

PowerLogic™ ION7400 series

User manual

7EN02-0374-00

11/2015



Legal Information

The Schneider Electric brand and any registered trademarks of Schneider Electric Industries SAS referred to in this guide are the sole property of Schneider Electric SA and its subsidiaries. They may not be used for any purpose without the owner's permission, given in writing. This guide and its content are protected, within the meaning of the French intellectual property code (Code de la propriété intellectuelle français, referred to hereafter as "the Code"), under the laws of copyright covering texts, drawings and models, as well as by trademark law. You agree not to reproduce, other than for your own personal, noncommercial use as defined in the Code, all or part of this guide on any medium whatsoever without Schneider Electric's permission, given in writing. You also agree not to establish any hypertext links to this guide or its content. Schneider Electric does not grant any right or license for the personal and noncommercial use of the guide or its content, except for a non-exclusive license to consult it on an "as is" basis, at your own risk. All other rights are reserved.

Electrical equipment should be installed, operated, serviced, and maintained only by qualified personnel. No responsibility is assumed by Schneider Electric for any consequences arising out of the use of this material.

As standards, specifications, and designs change from time to time, please ask for confirmation of the information given in this publication.

Safety information

Important information

Read these instructions carefully and look at the equipment to become familiar with the device before trying to install, operate, service or maintain it. The following special messages may appear throughout this bulletin or on the equipment to warn of potential hazards or to call attention to information that clarifies or simplifies a procedure.



The addition of either symbol to a “Danger” or “Warning” safety label indicates that an electrical hazard exists which will result in personal injury if the instructions are not followed.



This is the safety alert symbol. It is used to alert you to potential personal injury hazards. Obey all safety messages that follow this symbol to avoid possible injury or death.

DANGER

DANGER indicates a hazardous situation which, if not avoided, **will result in** death or serious injury.

WARNING

WARNING indicates a hazardous situation which, if not avoided, **could result in** death or serious injury.

CAUTION

CAUTION indicates a hazardous situation which, if not avoided, **could result in** minor or moderate injury.

NOTICE

NOTICE is used to address practices not related to physical injury.

Please note

Electrical equipment should be installed, operated, serviced and maintained only by qualified personnel. No responsibility is assumed by Schneider Electric for any consequences arising out of the use of this material. A qualified person is one who has skills and knowledge related to the construction, installation, and operation of electrical equipment and has received safety training to recognize and avoid the hazards involved.

Notices

FCC

This equipment has been tested and found to comply with the limits for a Class B digital device, pursuant to part 15 of the FCC rules. These limits are designed to provide reasonable protection against harmful interference in a residential installation. This equipment generates, uses, and can radiate radio frequency energy and, if not installed and used in accordance with the instructions, may cause harmful interference to radio communications. However, there is no guarantee that the interference will not occur in a particular installation. If this equipment does cause harmful interference to radio or television reception, which can be determined by turning the equipment off and on, the user is encouraged to try to correct the interference by one or more of the following measures:

- Reorient or relocate the receiving antenna.
- Increase the separation between the equipment and receiver.
- Connect the equipment to an outlet on a circuit different from that to which the receiver is connected.
- Consult the dealer or an experienced radio/TV technician for help.

The user is cautioned that any changes or modifications not expressly approved by Schneider Electric could void the user's authority to operate the equipment.

This digital apparatus complies with CAN ICES-3 (B) /NMB-3(B).

About this manual

This manual discusses features of the PowerLogic™ ION7400 series power meter and provides configuration instructions.

Throughout the manual, the term “meter” refers to all models of the ION7400. All differences between the models, such as a feature specific to one model, are indicated with the appropriate model number or description.

This manual assumes you have an understanding of power metering and are familiar with the equipment and power system in which your meter is installed.

This manual does not provide configuration information for advanced features where an expert user would perform advanced configuration. It also does not include instructions on how to incorporate meter data or perform meter configuration using energy management systems or software, other than ION Setup. ION Setup is a free configuration tool available for download from www.schneider-electric.com.

Please contact your local Schneider Electric representative to learn what additional training opportunities are available regarding the ION7400 meter.

The most up-to-date documentation about your meter is available for download from www.schneider-electric.com.

Related documents

Document	Number
PowerLogic™ ION7400 installation sheet	NHA51491
PowerLogic™ ION7403 installation sheet	NHA77417
ION Reference	70002–0290
ION device template reference	—

Table of Contents

Important information	3
Please note	3
FCC	4
Safety precautions	11
Meter overview	12
ION7400 overview	12
Your meter in an energy management system	12
Measured parameters	13
Localization	15
Data display and analysis tools	15
Supported protocols	15
ION Setup device configuration tool	16
Meter types	16
Mounting adaptors	16
Terminal covers	16
Replacement hardware	17
Basic setup	18
Default values for commissioning	18
Meter setup	18
Volts mode	18
PT/CT setup	18
Voltage polarity setup	19
Current polarity setup	19
Nominal values	19
Minimum configuration requirements for basic metering	19
Lost user access	19
Hardware reference	20
Supplemental information	20
Meter base	20
Panel meter	20
DIN meter	20
Remote meter display (RMD)	21
Mounting adaptors	21
Terminal covers	21
Replacement hardware	21
LED locations	22
Energy pulsing LED behavior	22
Revenue lock LED behavior	22
Remote display connection LED behavior	22
Panel-mount meter and remote display mounting and wiring recommendations	23
Power system wiring	23
RS-485 wiring	23
RS-485 cable	23
RS-485 terminals	24
Ethernet communications connections	24
Option modules overview	24

- Maximum number of option modules 25
- USB (integrated display only) 25
- USB port location..... 25
- Meter display** 26
 - Display overview 26
 - Mode indicator 26
 - Home button..... 26
 - Revenue lock icon 27
 - Alarm icon..... 27
 - Alarm and status LED indicators 27
 - Navigation symbols 28
 - More screens access 29
 - Overrange indication..... 29
 - Display screens 29
 - Display modes 29
 - Alt mode display menu 29
 - Setup menu 34
 - Creating custom displays using ION Setup 37
 - Display scaling 38
 - Remote display troubleshooting icons 39
- Security**..... 40
 - Security overview 40
 - Standard and advanced security features 40
 - Advanced security user configuration 40
 - Security configuration process 40
 - Communications protocol lockout overview 41
 - Security recommendations and best practices 41
 - Password setup..... 42
 - Changing your meter’s display password using the display 43
 - Configuring standard security using ION Setup 43
 - Configuring users and passwords using ION Setup (advanced security only) 44
 - Loading an existing security configuration file (.scf) using ION Setup 45
- Communications** 46
 - Communications overview 46
 - Configuring communications using the display 46
 - Ethernet..... 46
 - Ethernet communications connections 46
 - Ethernet configuration 47
 - Protocols, ports and connections..... 47
 - Self-discovery over Ethernet..... 48
 - Serial..... 49
 - Serial communications 49
 - Serial protocols and ports 50
 - Communications setup..... 50
 - RS-485 configuration 52
 - Optical port overview..... 53
 - Configuring your meter with ION Setup over USB 55
- ION 55
- Modbus 56

Key terms.....	56
Your meter as a Modbus slave on a serial network.....	56
Your meter as a Modbus slave over Ethernet	57
Your meter as a Modbus master with serial Modbus slave devices	57
Your meter as a Modbus master with Ethernet Modbus slave devices	57
Supported Modbus features.....	57
Modbus implementation	58
Modbus best practices for serial	59
Modbus best practices for Ethernet	60
Modbus master best practices	60
Modbus map	60
Ethernet gateway	64
EtherGate	64
Modbus Ethernet gateway	65
FTP	67
FTP memory allocation.....	67
FTP file structure and permissions	67
FTP filename requirements.....	68
Accessing your meter's FTP server	68
SNMP.....	68
Simple Network Management Protocol (SNMP)	68
The meter in an SNMP system.....	69
SNMP implementation.....	69
Default SNMP mapping.....	71
IEC 61850.....	74
IEC 61850 implementation	74
COMTRADE	76
Configuring COMTRADE waveform recording using ION Setup.....	77
Downloading COMTRADE files using ION Setup.....	77
DNP	78
DNP supported features and default implementation	78
Time and timekeeping	79
Time overview	79
Time synchronization overview	79
Supported time synchronization sources	79
Configuring time information using your meter's display.....	80
Configuring time and time synchronization using ION Setup	80
Maintenance	83
Firmware and templates.....	83
Firmware and template overview.....	83
Firmware overview.....	83
Typical workflows.....	83
Laptop computer upgrade considerations	84
Firmware upgrade considerations	84
Test mode	88
Test mode default screens	89
Troubleshooting	90
Technical assistance	90
Option module troubleshooting	90

Meter webpages.....	91
Webpage interface	91
Default meter webpages	91
Accessing the meter's webpages for data viewing and meter configuration	92
Viewing files using your meter's webpages	93
Creating custom webpages for your meter.....	93
Sample data viewing webpage	94
Sample webpage data viewing result.....	94
Logging.....	102
Logging overview	102
Default logging capacity	102
Log depth configuration.....	102
Log interval configuration	103
Data log memory calculations	103
Waveform record memory calculations.....	103
Data logging overview.....	104
Default data logging configuration	104
Revenue log	104
Historic data logs	105
Loss log	105
Harmonics logs.....	106
Energy/demand log.....	106
Sag/swell log	106
EN50160 compliance logs	106
4-30 compliance logs	107
Event log overview	108
Default event log configuration.....	108
Waveform recording overview	109
Key terms.....	109
Default waveform recording configuration.....	110
Configuring waveform recording using ION Setup	110
Setpoint learning overview	111
Learning installation mode and learning duration.....	112
Inputs / outputs.....	114
I/O Overview	114
Input/output ION modules	114
Input/output ION modules, ports and labels	114
I/O option modules	116
Analog inputs	117
Analog input applications.....	117
Analog input voltage and current mode.....	117
Analog input behavior.....	117
Analog input zero scale and full scale values.....	117
Analog outputs	118
Analog output applications.....	118
Analog output behavior	119
Analog output zero scale and full scale values.....	119
Digital inputs	120
Digital input applications	120
IRIG-B time synchronization	120

WAGES monitoring	122
WAGES example	122
Input metering	122
Digital outputs	124
Digital output applications	124
Energy pulsing	126
Default energy pulsing LED sources	126
Alarms and alerts	129
Alarms overview	129
Alarm types	129
Alarm event priorities	131
Info only and none event priority	131
Alarm indicators	132
Default alarms	132
Alarm information	133
Viewing and acknowledging alarms using the meter's display	133
Alarm configuration	133
Alerting	138
Resets	139
Meter resets	139
Option module reset	139
Available resets	139
Measurements	143
Power and power factor	143
Power demand	145
WAGES monitoring	146
Incremental energy	147
Incremental energy example	147
Conditional energy	148
Trending and forecasting overview	149
Power quality	151
Power quality overview	151
Sag/swell overview	151
Harmonics overview	151
Voltage crest factor	152
Crest factor current	152
K-factor	152
Harmonic content calculations	152
TDD calculations	153
Phasors	153
Disturbance direction detection overview	153
Verifying accuracy	155
Overview of meter accuracy	155
Accuracy test requirements	155
Signal and power source	155
Control equipment	155
Environment	155
Reference device or energy standard	156
Energy pulsing	156
Verifying accuracy test meter settings	156

Verifying accuracy test	157
Calculate the number of required pulses.....	158
Percentage error calculation for accuracy verification testing	158
Typical sources of test errors	159
Accuracy verification test points	159
Revenue	160
Revenue locking.....	160
PT/CT correction.....	161
Transformer line loss compensation	161
Time of use	162
Specifications	163

Safety precautions

Installation, wiring, testing and service must be performed in accordance with all local and national electrical codes.

⚠ DANGER

HAZARD OF ELECTRIC SHOCK, EXPLOSION, OR ARC FLASH

- Apply appropriate personal protective equipment (PPE) and follow safe electrical work practices. See NFPA 70E in the USA, CSA Z462 or applicable local standards.
- Turn off all power supplying this device and the equipment in which it is installed before working on the device or equipment.
- Always use a properly rated voltage sensing device to confirm that all power is off.
- Treat communications and I/O wiring connected to multiple devices as hazardous live until determined otherwise.
- Do not exceed the device's ratings for maximum limits.
- Never short the secondary of a potential/voltage transformer (PT/VT).
- Never open circuit a current transformer (CT).
- Always use grounded external CTs for current inputs.
- Do not use the data from the meter to confirm power is off.
- Replace all devices, doors and covers before turning on power to this equipment.

Failure to follow these instructions will result in death or serious injury.

NOTE: See IEC 60950-1:2005, Annex W for more information on communications and I/O wiring connected to multiple devices.

⚠ WARNING

UNINTENDED OPERATION

Do not use this device for critical control or protection applications where human or equipment safety relies on the operation of the control circuit.

Failure to follow these instructions can result in death, serious injury, or equipment damage.

Meter overview

ION7400 overview

The PowerLogic™ ION7400 energy and power quality meters help meet the needs of your energy monitoring and cost management applications.

ION7400 meters comply to international metering accuracy standards. You can customize your meter by loading specialized frameworks, adding option modules and incorporating mounting accessories into the physical installation.

Meter features

EN50160 including flicker monitoring
Power quality readings (THD)
Sag/swell capture for voltage and currents
True RMS metering to the 63rd harmonic
Active (kW), reactive (kVAR) and apparent (kVA) power
600 V direct connection on voltage inputs
Minimum/maximum readings of metered data
Transformer and Line Loss Compensation (TLC/LLC)
WAGES support
Time of use support
Trending and forecasting
Time synchronization to 1 ms accuracy
Test mode
ANSI type 2 optical port
USB ports (on meters with integrated display)
Dual port Ethernet (two physical ports, one Ethernet IP address)
Multiple languages supported
Web interface
Configuration through integrated or remote display
Alarms (active and historic) display viewing and acknowledgment
Modbus master and Ethernet gateway protocols supported
Downloadable firmware and templates

Your meter in an energy management system

As a key piece in your energy management system, the meter provides highly accurate measurements and calculations for a wide variety of power system values, performs analysis on collected data, alerts you of potential issues and integrates with a variety of display and analysis software.



Perform basic setup using the color LCD display, the meter webpages or ION Setup	Configure meter to help protect against unauthorized configuration of your meter and access to your meter's data
Customize meter functionality using the power of ION	Improve energy efficiency and track compliance to green standards
Access highly accurate measurements and calculations for a wide variety of power system values	Help prolong asset life with proactive network management
Use the onboard or extendible I/O for non-critical control, WAGES and input metering, energy pulsing and system monitoring (for example, breaker status)	Log data in a number of onboard default logs, or customize your meter to log other parameters, and access that information using software or webpages
Receive notifications of predefined meter and system events or create custom alarms	Time of use and perform cost allocation/tenant billing
Track the trends for power system values over time to understand energy usage patterns, optimize network capacity and forecast future usage	Easily access information after basic configuration using: <ul style="list-style-type: none"> • a variety of industry-standard protocols • software such as Power Monitoring Expert and PowerSCADA Expert • the meter's internal webpages (standard or customized to suite your needs) • the optional remote display (DIN models) • from downstream devices by using the meter as a gateway
Monitor compliance to a variety of power quality standards using the meter's highly accurate metering Use the meter's setpoint learning feature to learn your power system's normal operating values Locate disturbances using disturbance direction detection	

Measured parameters

Energy

Your meter provides bi-directional 4-quadrant energy metering.

Your meter provides active, reactive and apparent energy values.

- kWh, kVARh, kVAh delivered and received
- kWh, kVARh, kVAh net (delivered - received)
- kWh, kVARh, kVAh total (delivered + received)
- Volt-squared-hours and amp-squared-hours

Energy parameters can be logged automatically on a programmed schedule.

All energy values represent the total for all three phases.

Demand

Your meter supports several demand calculation methods, including block, rolling block, synchronized and predicted demand.

It can measure demand on any instantaneous value and record peak (maximum) and minimum demand with time and date information.

- kW, kVAR, kVA demand
- kW, kVAR, kVA peak demand
- Amps, Volts demand

Instantaneous

Your meter provides one second and half-cycle measurements, per phase and totals for many values.

- Voltage and current
- Apparent power (kVA), active power (kW) and reactive power (kVAR)
- Power factor and frequency
- Voltage and current unbalance

Harmonics

Your meter provides harmonic distortion metering, recording and real-time values for all voltage and current inputs.

- Individual harmonics (including magnitude and phase angle) up to the 63rd harmonic
- Total even harmonic distortion (TEHD) and total odd harmonic distortion (TOHD)
- Total harmonic distortion (THD) or total demand distortion (TDD)
- K-factor, Crest factor

Min/max recording

Your meter records new minimum and maximum data every recording interval for a variety of values.

- Voltage and current
- kW, kVAR and kVA
- Power factor
- Frequency
- Voltage unbalance
- Plus any measured value

Power quality

Your meter measures and records voltage and current sags and swells.

Your meter also has many power quality related features.

- Disturbance direction detection: this allows the meter to analyze disturbance (sag/ swell) information to help determine the direction of the disturbance relative to the meter.
- Setpoint learning: this allows the meter to learn the power quality characteristics of your system, to help identify what constitutes a sag or a swell.
- COMTRADE: this allows the meter to save waveform data in COMMon format for TRAnsient Data Exchange (COMTRADE) on its internal FTP server.

Your meter includes the following power quality compliance:

- EN50160: Your meter measures and presents statistics for determining EN50160 compliance.
- IEC 61000-4-30: Your meter complies with the IEC 61000-4-30 power quality standard.

- IEC 62586: Your meter complies with the IEC 62586 power quality standard.

Localization

The meter can be customized to use different regional settings.

Localization settings determine:

- The language used for the display and webpages
- Time, date and digit formats
- Displayed phase labels (123/ABC)
- IEEE (Institute of Electrical and Electronics Engineers) or IEC (International Electrotechnical Commission) conventions for power, power factor and energy

You can configure your meter's localization settings through the display or using ION Setup.

Data display and analysis tools

Display

Use the meter's display for local monitoring and standalone applications.

The color LCD display lets you view real-time values, events and alarms, and perform basic device configuration. Connect a remote display to a meter without an integrated display to view meter data and perform basic meter configuration.

Active and historical alarms

The meter's display shows an alarm icon and the alarm LED flashes if your meter detects an active alarm condition.

Depending on the priority of the alarm, your meter's display also flashes. You can view and acknowledge active alarms and historic alarms and events through the display and software webpages. An active alarm becomes a historic alarm when the alarm condition no longer exists.

Meter internal web server feature

Your meter's internal web server provides quick and easy access to real-time energy and basic power quality information without special software using an on-board web server combined with an Ethernet port.

The built-in web pages display selected energy and power quality information through the web-enabled device; these pages also support basic meter configuration.

Email messaging feature

You can configure your meter to automatically email information, whether notification of a high-priority event or a regularly scheduled send of logged data, to an external email address.

Specify the type of event that triggers an email alert, such as a power quality disturbances or interval for logged data. Email messages from your meter are received like any other email message.

Supported protocols

Your meter's fundamental protocol and architecture is ION.

You can integrate the meter into various industry-standard networks. Data that the meter measures can be made available to other devices using Modbus, DNP 3.0

and SNMP as well as the MV-90 translation system. You can configure the meter to import data from other devices on these networks. Your meter supports the IEC 61850 protocol and COMTRADE waveform data format.

Your meter also supports IPv6, DPWS and RSTP Ethernet protocols.

ION Setup device configuration tool

ION Setup is a free configuration tool for your meter that allows you to remotely configure your meter's features over Ethernet or serial communications.

- Use the setup screens to guide you through the process of configuring your meter.
- Use the real-time data screens to verify your meter's configuration.
- Use the data screens to view your meter's recorded data.
- Use the charting function to view your meter's recorded waveforms.

You can download ION Setup from www.schneider-electric.com.

See the online ION Setup help, available from www.schneider-electric.com, for instructions on connecting to your meter.

Meter types

The ION7400 series is available in two physical form factors, and has several accessories.

Model	Commercial reference	Description
ION7400	METSEION7400	Panel-mounted meter with integrated display
ION7403	METSEION7403	DIN rail-mounted meter without display, which can be connected to a remote display
PM89RD96	METSEPM89RD96	Remote display (for DIN meter only)
PM89M2600	METSEPM89M2600	Digital I/O option module (2 out, 6 in)
PM89M0024	METSEPM89M0024	Analog I/O option module (2 out, 4 in)
PM8000SK	METSEPM8000SK	Voltage and current sealing kit
METSEPPMAK	METSEPPMAK	Mounting adapter kit for remote display and DIN meter

Refer to your meter's catalog pages, available from www.schneider-electric.com, for updated information on meter types and accessories.

Mounting adaptors

There are different mounting adaptor accessories that can help when installing your meter in existing panels and cutouts where the default mounting hardware is not appropriate.

Mounting adaptor kits are ordered separately from the meter.

Terminal covers

The voltage and current terminal covers help prevent tampering with the meter's voltage and current measurement inputs.

The terminal covers enclose the terminals, the conductor fixing screws and a length of the external conductors and their insulation. The terminal covers are secured by tamper-resistant meter seals.

These covers are included for meter models where sealable voltage and current covers are required to comply with revenue or regulatory standards.

The meter terminal covers must be installed by a qualified installer.

Refer to the Sealing kit instruction sheet for instructions on installing the terminal covers.

Replacement hardware

You can order replacement mounting and installation hardware for your meter and accessories.

Basic setup

Default values for commissioning

Use these default values the first time you connect to and configure your meter.

Parameter	Default value
Display password (also for logging onto meter webpages)	0
Username (for logging onto meter webpages)	7400
IP address	169.254.0.10
Subnet mask	255.240.0.0
Gateway	0.0.0.0
RS-485	Unit ID: 100
Language	English

Meter setup

You can configure your meter's basic metering parameters using the display.

Volts mode

Parameter	Values	Description
Volts Mode	4W-Wye, Delta, 3W-Wye, Single, Demo	The power system's configuration
PhaseOrder	ABC, ACB	The power system's phase order

PT/CT setup

Parameter	Values	Description
PT Primary	1 to 999,999.99	The potential transformer's primary winding voltage rating NOTE: PTs are also referred to as VTs or voltage transformers.
PT Secondary	1 to 999,999.99	The potential transformer's secondary winding voltage rating NOTE: PTs are also referred to as VTs or voltage transformers.
CT Primary	1 to 999,999.99	The current transformer's primary winding current rating
CT Secondary	1 to 999,999.99	The current transformer's secondary winding current rating
I4 Primary	1 to 999,999.99	The I4 current transformer's primary winding current rating
I4 Secondary	1 to 999,999.99	The I4 current transformer's secondary winding current rating

Voltage polarity setup

Parameter	Values	Description
Va Polarity	Normal, Inverted	The polarity of the potential transformer on Va
Vb Polarity	Normal, Inverted	The polarity of the potential transformer on Vb
Vc Polarity	Normal, Inverted	The polarity of the potential transformer on Vc

Current polarity setup

Parameter	Values	Description
Ia Polarity	Normal, Inverted	The polarity of the current transformer on Ia
Ib Polarity	Normal, Inverted	The polarity of the current transformer on Ib
Ic Polarity	Normal, Inverted	The polarity of the current transformer on Ic
I4 Polarity	Normal, Inverted	The polarity of the current transformer on I4

Nominal values

Parameter	Values	Description
V Nominal	1 to 999,999	The nominal (normal) voltage of the power system
I Nominal	1 to 999,999	The nominal (normal) current of the power system
Nominal Frequency	50, 60	The nominal (normal) frequency of the power system

Minimum configuration requirements for basic metering

At a minimum, you must configure some parameters to help your meter perform basic metering functions.

Setup screen	Screen	Minimum configuration
Meter Setup	Volts Mode	Volts mode
	PT/CT Setup	PT, CT and I4 CT primary and secondary
	Nominal values	V nominal, I nominal, Nominal frequency

NOTE: You must also configure all the parameters related to the meter features you are using, for example, you must configure the DNS server address if you are using the meter's DNS feature.

Lost user access

If you lose your meter's user access (password) information, contact your local Schneider Electric representative for instructions on how to return your meter for factory reconfiguration.

NOTE: Have your meter's serial number available for reference.

Hardware reference

Supplemental information

This document is intended to be used in conjunction with the installation sheet that ships in the box with your meter and accessories.

See your device's installation sheet for information related to installation.

See your product's technical datasheet at www.schneider-electric.com for the most up-to-date and complete specifications.

See your product's catalog pages at www.schneider-electric.com for information about your device, its options and accessories.

You can download updated documentation from www.schneider-electric.com or contact your local Schneider Electric representative for the latest information about your product.

Meter base

Your meter base has two form factors: panel mount with an integrated display and DIN mount.

Panel meter

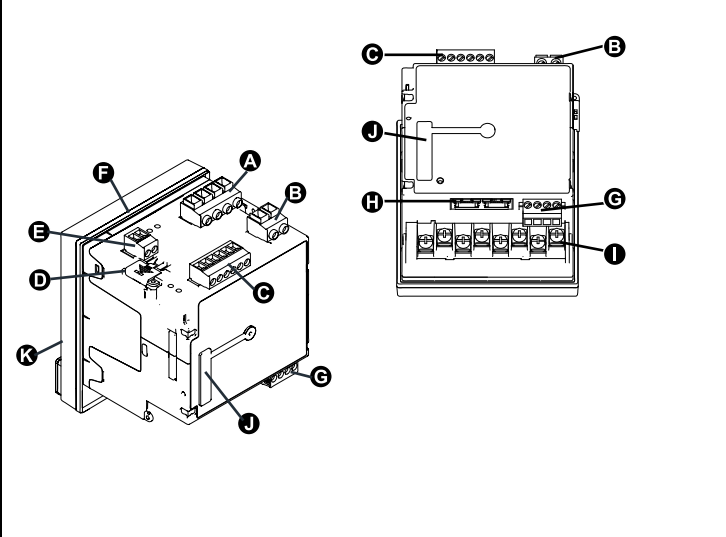

A	Voltage inputs
B	Control power
C	Digital inputs (3)
D	Revenue lock switch cover
E	Digital output
F	Gasket
G	RS-485
H	Ethernet (2)
I	Current inputs
J	Option module connector
K	Display with optical port and USB

Mounting hardware and accessories not shown

DIN meter

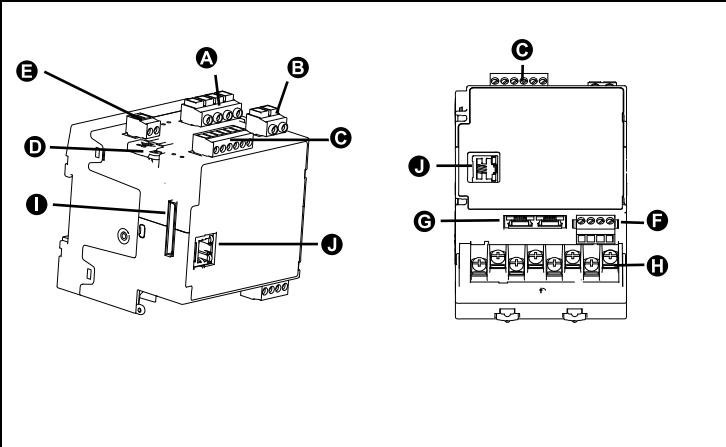

A	Voltage inputs
B	Control power
C	Digital inputs (3)
D	Revenue lock switch cover
E	Digital output
F	RS-485
G	Ethernet (2)
H	Current inputs
I	Option module connector
J	Remote display connector

Mounting hardware and accessories not shown

Remote meter display (RMD)

The remote meter display can be used with DIN meters.

It has the same buttons and icons as the display on a panel meter, and is powered by the connection to the meter. A remote display cannot be used with meters that have an integrated display

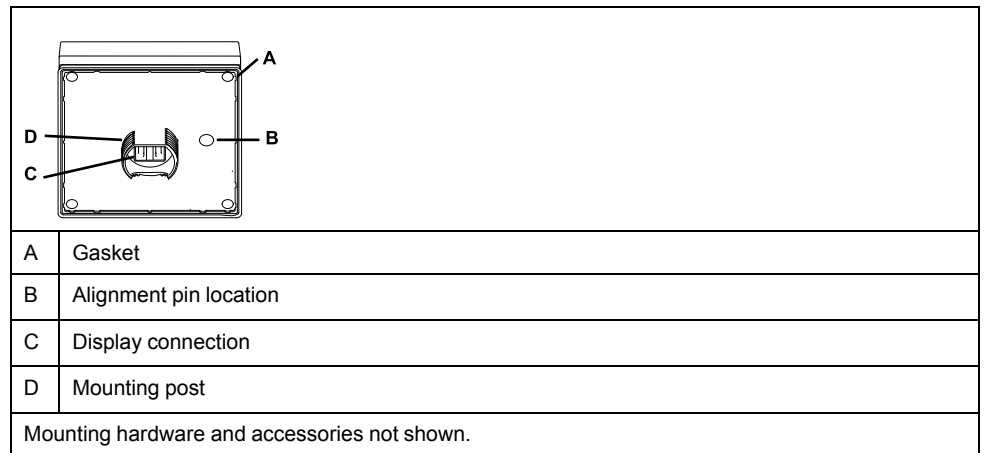

Mounting adaptors

There are different mounting adaptor accessories that can help when installing your meter in existing panels and cutouts where the default mounting hardware is not appropriate.

Mounting adaptor kits are ordered separately from the meter.

Terminal covers

The voltage and current terminal covers help prevent tampering with the meter's voltage and current measurement inputs.

The terminal covers enclose the terminals, the conductor fixing screws and a length of the external conductors and their insulation. The terminal covers are secured by tamper-resistant meter seals.

These covers are included for meter models where sealable voltage and current covers are required to comply with revenue or regulatory standards.

The meter terminal covers must be installed by a qualified installer.

Refer to the Sealing kit instruction sheet for instructions on installing the terminal covers.

Replacement hardware

You can order replacement mounting and installation hardware for your meter and accessories.

LED locations

The LED indicators alert or inform you of meter activity.

A	Alarm
B	Status
C	VAR energy pulsing LEDs (visible and infrared, integrated display only)
D	Watts energy pulsing LEDs (visible and infrared, integrated display only)
E	Energy pulsing LEDs (visible and infrared)
F	Revenue lock status
G	Remote display connection link
H	Remote display connection activity

Related Topics

- Alarm and status LED indicators

Energy pulsing LED behavior

The visible and infrared LEDs are configured by default to pulse based on energy measured by the meter.

You can configure the pulse weight (pulses per kWh) and the energy source.

Energy pulsing is used to help verify the energy measurement accuracy of your meter for revenue purposes.

Revenue lock LED behavior

The revenue lock LED indicates the lock status of the meter.

State	Description
Off	The meter is not revenue locked.
On	The meter is revenue locked.
Flashing	New revenue lock state is pending; power cycle your meter to set the revenue lock to on or off.

Remote display connection LED behavior

There are two LEDs in the remote display connector that indicate the state of communications between the meter and remote display.

LED	Description
Green (link)	On: link established. Off: no link established with the remote display. Check the connections to the remote display and DIN meter.
Yellow (activity)	Flashing: active communications between the meter and the remote display. Off: no communication activity. Check remote display and meter operation.

Panel-mount meter and remote display mounting and wiring recommendations

There are supplemental mounting and wiring recommendations that apply to panel-mount meters and remote displays.

- The meter is intended to be mounted inside a ¼-DIN panel cutout.
- Inspect the gasket (installed around the perimeter of the display) and make sure it is secured properly and not damaged.
- The meter retainer clips, located on either side of the meter base and used to secure the meter in the panel, do not usually require any tools to install. If necessary, for panels with limited space, you can use a long-handled slot screwdriver to help install the meter retainer clips.
- The remote display can only be used with the DIN meter; it cannot be used by meters with an integrated display.
- The remote display's power and communications is provided through a single, direct, point-to-point connection from the remote display to the DIN meter.

Power system wiring

You can connect the meter's voltage inputs directly to the phase voltage lines of the power system if the power system's line-to-line or line-to-neutral voltages do not exceed the meter's direct connect maximum voltage limits.

The maximum voltage allowed for direct connection may be lower than the manufacturer-specified limits, depending on the local electrical codes and regulations.

If your system voltage is greater than the specified direct connect maximum voltage, you must use voltage (potential) transformers (VTs/PTs) to step down the voltages.

RS-485 wiring

Connect the devices on the RS-485 bus in a point-to-point configuration, with the (+) and (-) terminals from one device connected to the corresponding (+) and (-) terminals on the next device.

RS-485 cable

Use a shielded 2 twisted pair or 1.5 twisted pair RS-485 cable to wire the devices. Use one twisted pair to connect the (+) and (-) terminals, and use the other insulated wire to connect the C terminals

The total distance for devices connected on an RS-485 bus should not exceed 1200 m (4000 ft).

RS-485 terminals

C	Common. This provides the voltage reference (zero volts) for the data plus and data minus signals
	Shield. Connect the bare wire to this terminal to help suppress signal noise that may be present. Ground the shield wiring at one end only (either at the master or the last slave device, but not both).
-	Data minus. This transmits/receives the inverting data signals.
+	Data plus. This transmits/receives the non-inverting data signals.

NOTE: If some devices in your RS-485 network do not have the C terminal, use the bare wire in the RS-485 cable to connect the C terminal from the meter to the shield terminal on the devices that do not have the C terminal.

Ethernet communications connections

Your meter's dual port Ethernet connections enable you to use straight-line or network loop (ring) topologies.

If local network loop Ethernet topologies are required, you must enable RSTP for your meter's Ethernet communications to function.

Only use unshielded CAT5/5e UTP Ethernet cables to wire your meter's Ethernet communications. Other cable types may provide an undesired ground path.

NOTICE

EQUIPMENT DAMAGE

Only use unshielded CAT5/5e UTP Ethernet cables.

Failure to follow these instructions can result in equipment damage.

Option modules overview

Option modules are ordered separately from your meter, and can be connected to your meter without specialized equipment.

Option modules are identified based on the physical order of the attached modules. The option module attached directly to the meter is module A, the module attached to module A is module B, and so on. The option module identifier is added to the ION module name and ION label to uniquely describe each possible combination of option modules.

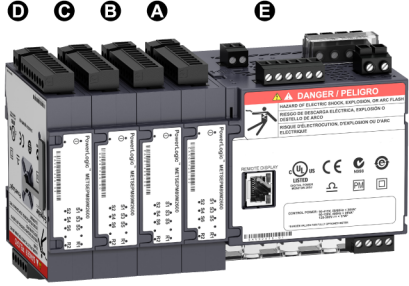
	
A	Option module A
B	Option module B
C	Option module C

D	Option module D
E	Meter

For example, a meter with two option modules, consisting of an analog option module directly attached to the meter (A) and a digital option module attached second (B), describes the Q2 analog output of module A as Port A Q2 and the S3 digital input of module B as Port B S3.

Maximum number of option modules

Depending on the type and quantity of option modules attached to your meter, you may need to reduce your meter’s maximum operating temperature.

For a panel mount meter, one limitation on the number of modules that can be attached is the physical strength of the meter mounting hardware. If your meter is mounted in an area subject to vibration or other physical stresses, your meter’s ability to physically support multiple option modules and maintain a seal against the mounting surface may be affected.

NOTICE
EQUIPMENT DAMAGE
Do not exceed the maximum number of option modules.
Failure to follow these instructions can result in equipment damage.

Related Topics

- Specifications

USB (integrated display only)

Models with an integrated display have USB ports.

You can use the mini-B USB port to connect to a computer running ION Setup to configure your meter. Other applications, programs and protocols are not supported.

NOTE: It is not recommended to use your meter’s mini-B USB port to upload firmware or paste templates because of long file transfer times.

The type A USB port is reserved for future use.

USB port location

The USB ports are located on the meter’s integrated display under a protective cover.

Flip the USB port cover up to expose the USB ports. Replace the USB port cover when the ports are not in use to help keep the USB ports clean.

	A	Mini-B USB
	B	Type A USB

Meter display

Display overview

The integrated or remote display allows you to view meter data and perform basic configuration.

The integrated display has USB ports, an optical port and energy pulsing LEDs. The integrated and remote display screens have the same meter data and setup screens. Only meters without an integrated display can use the remote display.

NOTE: Your meter’s display backlight dims after a defined period of inactivity. When the meter detects an unacknowledged active high priority alarm, the display flashes until the alarm is acknowledged.

Integrated and remote displays

A	Date/time
B	Mode indicator
C	Revenue lock icon
D	Alarm icon
E	Display
F	Navigation icons
G	Navigation buttons
H	Alarm LED
I	USB ports cover (integrated display only)
J	Home button
K	VAR infrared energy pulsing LED (integrated display only)
L	VAR energy pulsing LED (integrated display only)
M	Watt infrared energy pulsing LED (integrated display only)
N	Watt energy pulsing LED (integrated display only)
O	Optical port (integrated display only)
P	Status LED

Mode indicator

The display mode indicator identifies whether the meter is in normal (Norm), alternate display (Alt) or test (Test) mode.

Home button

The function of the home button varies depending on the meter’s display mode.

- Norm or test mode: When your meter is in norm or test mode, pressing the home button returns you to the mode selection screen.

- Alt mode or setup menu: When your meter is in alternate (alt) display mode or you are in the setup menu, pressing the home button takes you to the associated menu screen. If you are in an alt mode data screen, pressing the home button takes you to the display menu, and pressing home twice takes you to the summary display screen. If you are in a setup screen, pressing home takes you to the setup menu, and pressing home again takes you back to the last display mode data screen.

NOTE: To exit alt display mode, select **Normal Display Mode** from the alt display menu in order to access the mode selection screen.

Revenue lock icon

The revenue lock icon indicates the lock status of the meter.

When gray and open, the meter is unlocked. When green and closed, the meter is locked. You can lock and unlock your meter using the revenue lock switch located on the body of your meter.

Related Topics



- Revenue locking

Alarm icon

The alarm icon indicates the highest level and state of alarms detected by your meter.

For example, if the meter detects a low priority and a high priority active alarm, the alarm icon indicates a high priority active alarm.

NOTE: Alarms can only be viewed and acknowledged through your meter’s display.

Icon	Description
	<p>Active alarm indicator:</p> <ul style="list-style-type: none"> • Red: high priority alarm state detected • Yellow: medium priority alarm state detected • Blue: low priority alarm state detected <p>The alarm indicator flashes until you acknowledge the alarm.</p> <p>The alarm indicator changes to the historic alarm indicator of the appropriate level when the alarm state is no longer detected by the meter.</p> <p>NOTE: Your meter’s display backlight flashes for unacknowledged high priority active alarms.</p>
	<p>Unacknowledged historic alarm indicator:</p> <ul style="list-style-type: none"> • Red: unacknowledged high priority historic alarm • Yellow: unacknowledged medium priority historic alarm <p>NOTE: Low priority historical alarms are not indicated.</p> <p>The active alarm indicator changes to the historic alarm indicator of the appropriate level when the alarm state is no longer detected by the meter.</p>
	No active or unacknowledged high or medium priority historic alarms

Related Topics

- Alarms overview

Alarm and status LED indicators

Your meter has alarm and status LEDs on the display.

These LEDs cannot be configured for other uses.

LED	Description
Status	Off: unpowered Steady green: normal operation Flashing red: no communications (remote display only) Steady red: firmware upgrade required (remote display only) Flashing red/green: startup or firmware upgrade sequence in progress
Alarm	Off: no active or unacknowledged historic alarms On: acknowledged active alarm Flashing: active alarm NOTE: Your meter's display backlight flashes for unacknowledged high priority active alarms.











Related Topics



- LED locations

Navigation symbols

Navigation symbols are displayed on the bottom of the screen above their corresponding navigation button.

NOTE: If the symbol is gray, that navigation function is not available.

Symbol	Description
	More Pressing this button displays additional screens.
	Left Pressing this button moves the displayed cursor one position to the left. If you are in a more or info screen, it returns you to the previous screen.
	Right Pressing this button moves the displayed cursor one position to the right.
	Up Pressing this button takes you to the previous screen or menu item.
	Down Pressing this button takes you to the next screen or menu item.
	Select Pressing this button selects or confirms the highlighted value.
	Cancel Pressing this button cancels the current selection and returns you to the previous screen.
	Graphic Pressing this button takes you to a graphical data display.
	Numeric Pressing this button takes you to a numeric data display.
	Info Pressing this button takes you to a detailed information screen.
	Edit Pressing this button allows you to edit the displayed parameter.

Symbol	Description
	Pressing these buttons allow you to navigate parameter tables in the setup screens.
	Pressing both buttons allows you to perform the described action.

More screens access

You can access additional screens.

Pressing the navigation button associated with the more icon brings up a list of additional screens related to the displayed screen. Press cancel to remove the list. If you do not press any button, the list automatically disappears after a short period of time.

Overrange indication

If any value measured by the meter is too large to fit on the meter's display, the meter initially reduces the size of the text to try and make the value fit.

If the value is still too large to be displayed, the meter truncates the value starting with the least significant digit, and encloses the truncated value in a red box.

Display screens

Display modes

Your meter has three display modes and provides access to your meter's setup screens.

Your meter's display modes are:

- Norm (normal): In norm mode, your meter automatically scrolls through a series of customizable display screens. You can add or remove norm mode display screens. If there are no norm mode display screens, the meter displays a message stating that there are no available screens. To exit norm mode, press the home button to access the display modes selection screen.
- Alt (alternate): In alt mode, you navigate to view the different data screens. You cannot modify the default alt mode display screens, but you can add custom screens. To exit alt display mode, select **Normal Display Mode** to access the display modes selection screen.
- Test: In test mode, you manually scroll through a series of default screens. To exit test mode, press the home button and select **Exit Test Mode**.

NOTE: In test mode, your meter's billing quantities stop accumulating and the data is sent to special test mode registers. These registers are cleared when you exit test mode.

You can access your meter's setup screens from the display modes selection screen or by pressing the home button in alt or test mode. To exit the setup screens, press the home button.

Alt mode display menu

The alt mode display menu allows you to view data and access the setup menu.

NOTE: Your meter's menus may appear slightly different than shown depending on your display settings.

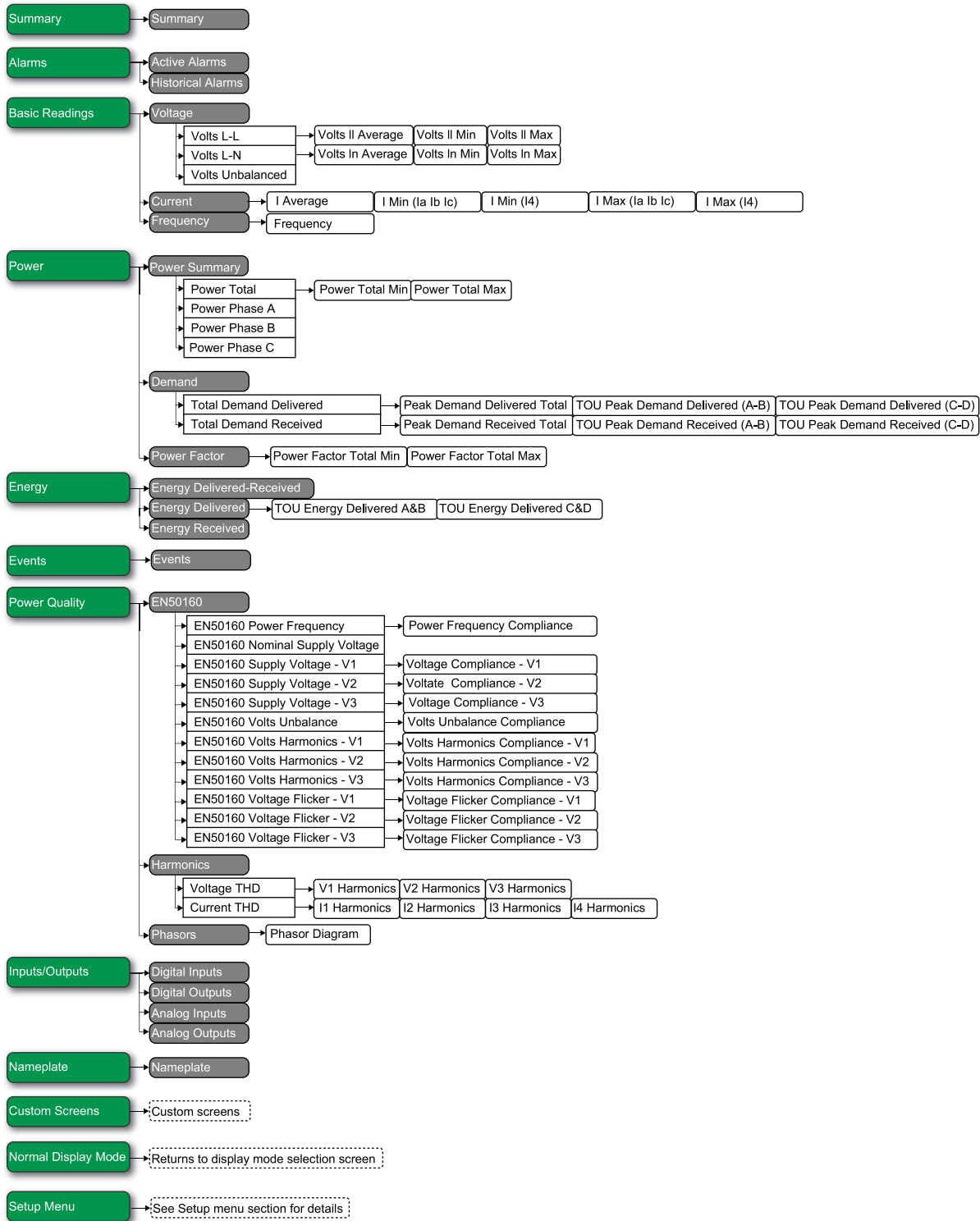

Alternate (alt) mode data display screens

Your meter's alt mode display screens show measured and calculated information about the power system being monitored.

NOTE: Minimum, maximum (peak), average and time of use (TOU) values are typically accessed by pressing the more button to show additional screens.

Menu	Menu screens	Content
Summary	Summary	Power system summary
Alarms	Active alarms, historical alarms	Active and historical alarms can be viewed and acknowledged.
Basic readings	Voltage, current, frequency	<ul style="list-style-type: none"> Power system voltage (line-to-line or line-to-neutral), current and frequency values.

Menu	Menu screens	Content
		<ul style="list-style-type: none"> Average, minimum and maximum values are also provided.
Power	Power summary, demand, power factor	<ul style="list-style-type: none"> Per-phase and total kW, kVAR and kVA values, along with minimum and maximum values. Delivered and received demand values including peak demand. Per-phase and total power factor along with minimum and maximum values.
Energy	Energy	Energy delivered-received, delivered and received.
Events	Events	Meter event log entries listing and details.
Power quality	EN50160, harmonics, phasors	<ul style="list-style-type: none"> EN50160 values. Voltage and current harmonics, with individual and total harmonic values. Phasor diagram with magnitude and angle values.
Inputs/outputs	Digital inputs, digital outputs, analog inputs, analog outputs	Digital and analog I/O values and counts.
Nameplate	Nameplate	Meter model, firmware version and serial number, along with owner and tag information.
Custom screens	—	Custom screens
Normal Display Mode	—	Access to the display mode selection screen.
Setup Menu	—	Access to the setup menu screens.

Data viewing using your meter’s display

Use the navigation buttons to view data on your meter’s display.







The following examples show how to use the navigation buttons to view data in numeric or graphical format, select and view additional menu screens, and view detailed information about alarms and acknowledge them.

NOTE: Your display may appear differently than shown, depending on your meter’s power system and display settings.

NOTE: Your navigation icons change color depending on the type of screen being viewed. If an icon is gray, that navigation option is not available and nothing will happen when you press the button associated with that icon.

Example: viewing the alarm screens

Use the display navigation buttons to access the alarm screens, display detailed information, and acknowledge active and historic alarms.

1. Press  to display the menu. Press  or  until **Alarms** is highlighted. Press  to display the alarm screens. Press  until **Active Alarms** is highlighted. Press  to display active alarms. The **Active Alarms** title lists, in brackets, the total number of active alarms.

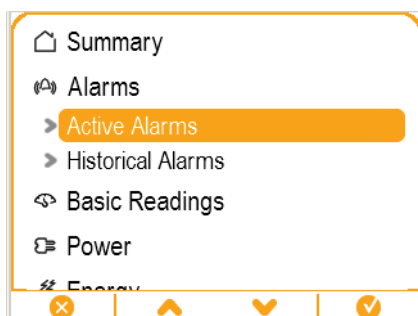

- Press or to highlight a specific alarm, in this case an unbalanced currents alarm. Press to display detailed information about the highlighted alarm, and press to return to the **Active Alarms** screen. Press both and simultaneously to acknowledge all active alarms.

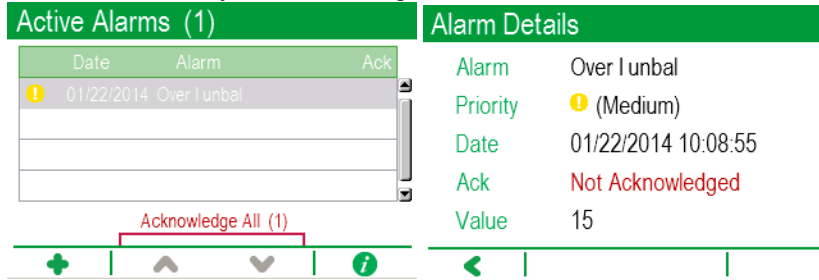

- Press to display the menu. Press to highlight **Historical Alarms**. Press to display historical alarms. The **Historical Alarms** title lists, in brackets, the total number of historic alarms.
- Press or to highlight a specific alarm, in this case a 4-30 voltage interruption alarm. Press to display detailed information about the highlighted alarm. Press both and simultaneously to acknowledge all historical alarms.

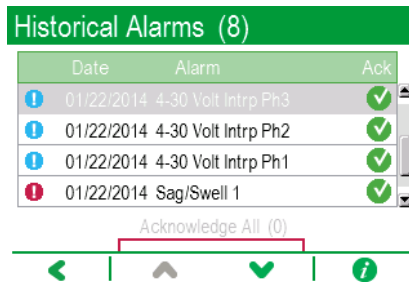

- Press to return to the menu.

Example: viewing the voltage screens

Use the display navigation buttons to view screens, display detailed information, and display graphical representations of measured voltage data.

- Press to display the menu. Press or until **Basic Readings** is highlighted. Press to view the basic readings screens. Press until **Voltage** is highlighted. Press to view the voltage screens. Voltage line-to-line values are displayed.

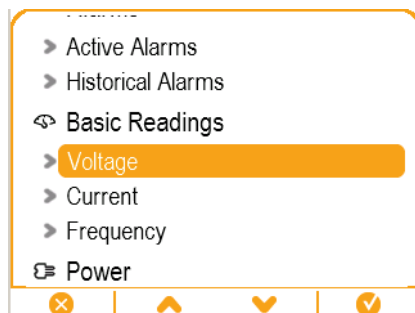

- Press to view a graphical display of historic voltage values, then press **888** to return to the numeric display. Press to show a list of additional screens.

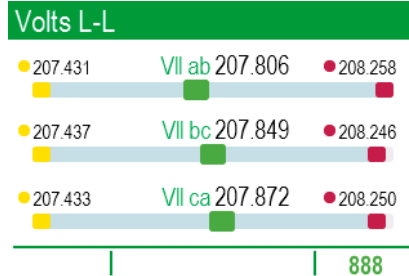
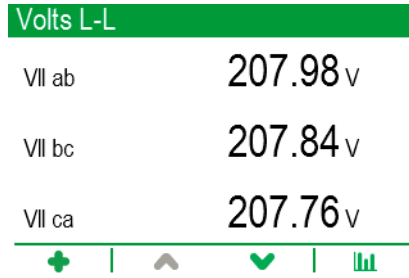

- Press or to highlight an additional screen, in this case, **Volts II**

Average. Press to go to the highlighted screen. **Volts II Average** displays the average line-to-line voltage.

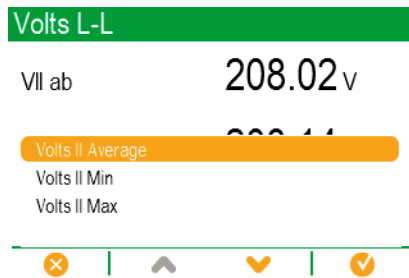

- Press to view a graphical display of average voltage values, then press **888** to return to the numeric display. Press to return to **Volts L-L**.

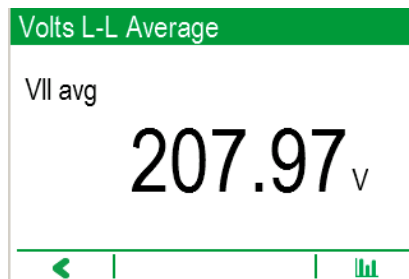

- Press to view **Volts L-N**, which also has additional screens and the ability to view the information in a graphical format.

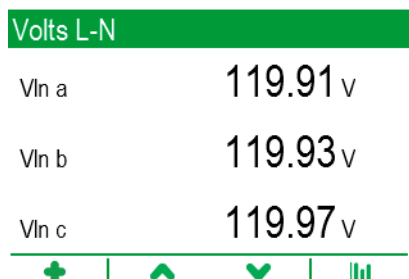

- Press again to view **Volts Unbalanced**. This is the last voltage screen, so is grayed out and unavailable. Press to return to **Volts L-N**, and press again to return to **Volts L-L**.

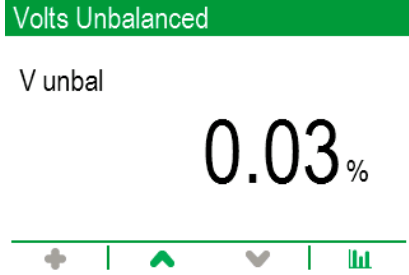

Setup menu

Meter configuration can be performed through the display.

You must have your meter’s security settings configured to allow front panel (display) programming in order to set up the meter using the display.

NOTE: Your display may appear differently than shown, depending on your meter’s power system and display settings.

NOTE: Some setup parameters cannot be configured when revenue security is enabled.

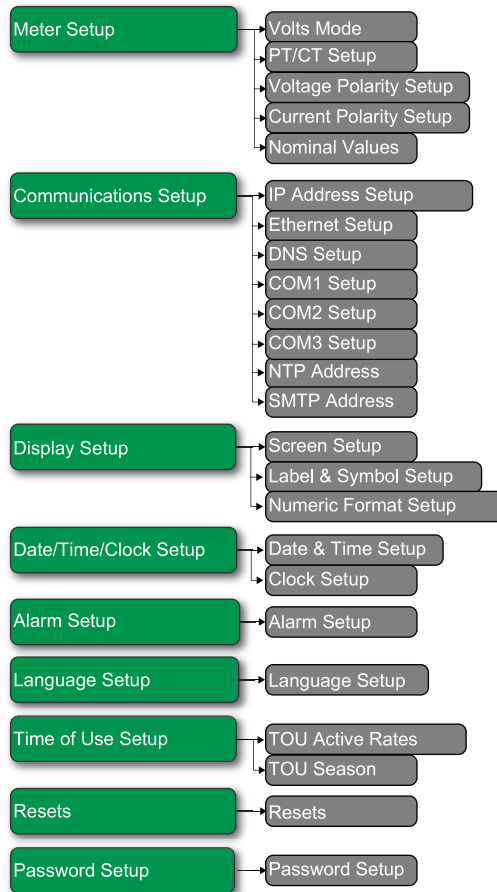

Meter setup using your meter’s display

Use the navigation buttons and displayed parameters to configure your meter.

The following example shows how to use the navigation buttons to select parameters, enter numeric information or select parameter values from lists.

NOTE: Your display may appear differently than those shown, depending on your meter’s power system and display and localization settings.

NOTE: Your navigation icons change color depending on the type of screen being viewed. If an icon is gray, that navigation option is not available and nothing will happen when you press the button associated with that icon.

NOTE: Your meter goes back to displaying data after a period of inactivity in the setup menu screens.



NOTE: Your meter locks you out of display configuration after you have exceeded the maximum number of attempts to enter a password.

Your meter's default display password is 0 (zero).





Example: setting volts mode and PT/CT ratios

Use the display navigation buttons to set your meter's volts mode and PT ratios.

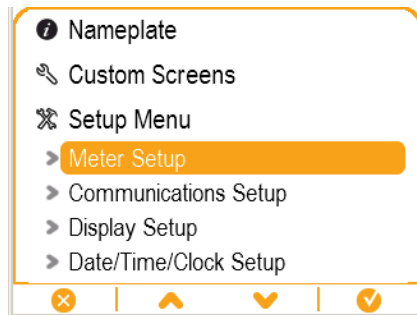

NOTE: Potential transformers (PT) are also known as voltage transformers (VT).

1. Press  to display the menu. Press  until **Setup Menu** is highlighted. Press  to display the **Setup Menu**. The **Setup Menu** lists the setup selections on your meter.

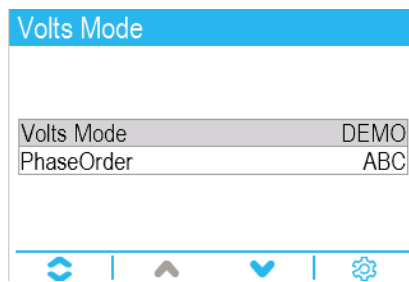

2. Press  or  to highlight the different setup menu selections. Highlight **Meter Setup** and press  to select the meter setup screens. The **Volts Mode** setup screen is displayed.
3. Press  to highlight **Volts Mode**. Press  to edit the volts mode. The **Enter Password** screen is displayed.



4. Press  to change the value of the highlighted digit (0 - 9). Press  to go to the next digit. Press  to enter your password. The **Volts Mode** configuration screen is displayed.

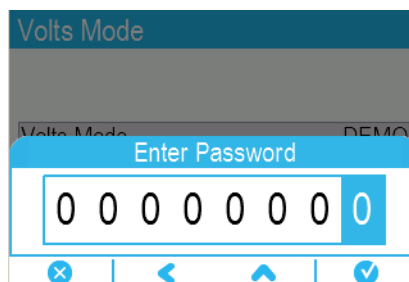

- Press or to highlight the desired volts mode from the list, in this case, 3W-WYE. Press to select the highlighted volts mode. A confirmation screen is displayed, showing your meter's previous setting and newly selected setting.

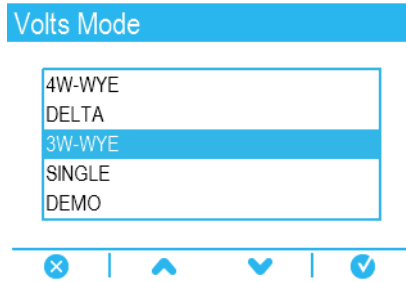

- Press to confirm, and the new setting is applied to your meter. Press to cancel and maintain your meter's original setting.

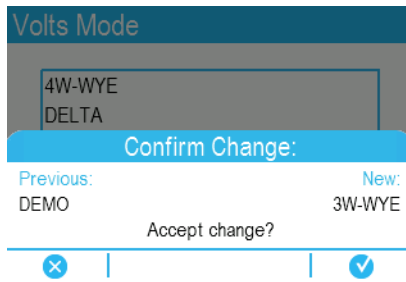

- In the **Volts Mode** screen, press to go to the **PT/CT Setup** screen.
- In the **PT/CT Setup** screen, press to highlight the potential transformer (PT) or current transformer (CT) value for editing. Press to edit the highlighted value.

NOTE: If you have exceeded the password timeout period, you are prompted to enter your meter's display password.

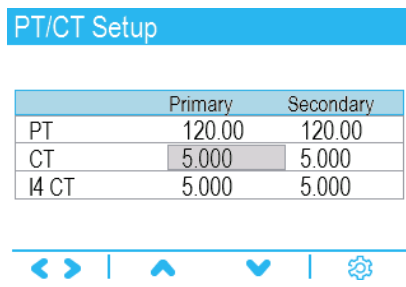

- Press to change the value of the highlighted digit (0 - 9). Press to go to the next digit. Press to enter the new value. When the confirmation screen is displayed, press to confirm the new value or to revert to the original value.

Related Topics

- Security overview
- Minimum configuration requirements for basic metering

Display setup

You can configure your meter's basic display parameters using the display.

Screen setup

Parameter	Values	Description
Backlight Timeout	0 to 720	Specifies how many seconds the display's backlight remains lit after the last button press

Label & symbol setup

Parameter	Values	Description
Phase Lbls	ABC, 123	Sets the voltage and current phase labels
Measurement Symbols	IEEE, IEC	Specifies whether IEEE or IEC measurement symbols are applied to displayed values
PF Convention	IEEE, IEC	Specifies whether IEEE or IEC power factor conventions are applied to displayed values

Numeric format setup

Parameter	Values	Description
Digit Grouping	1000.0, 1,000.0, 1 000,0	Specifies how digits are grouped for display
Volts Resolution	1., 1.X, 1.XXX, 1.XXXX	Specifies the number of decimal places displayed for voltages
Current Resolution	1., 1.X, 1.XXX, 1.XXXX	Specifies the number of decimal places displayed for currents
Power Resolution	1., 1.X, 1.XXX, 1.XXXX	Specifies the number of decimal places displayed for power and energy measurements

Language setup

Select the language to be shown on the meter's display.

By default, your meter has the following languages:

- English
- Spanish
- French
- German
- Italian
- Portuguese
- Russian
- Chinese (simplified)

Creating custom displays using ION Setup

You can use ION Setup to create new custom displays.

1. Start ION Setup.
2. Open the Setup Assistant for your meter.
3. Navigate to **Displays**.
4. Select **Displays** from the **Front Panel** tab and click **Edit**. ION Setup loads your meter's display information into the **Display Editor** screen.

5. Select the display mode of the custom screens from the dropdown list, and rename, delete, or change the order of custom displays.
 - a. Click **New** to add a new display screen in the selected display mode.
 - b. Click **Edit** to bring up the **Display setup** screen, where you can configure new or existing custom displays.
6. Configure your screen.
 - **Screen Type**: Specify the number of parameters displayed on the screen.
 - **Screen Title**: Enter the title to be shown at the top of your custom display.
7. Click **Edit** to select the displayed parameters.
The number of parameters displayed is determined in the **Screen Type** selection described above.
8. Select your digit display properties.
 - **Resolution**: Specifies the number of decimal places displayed.
 - **Last Digit**: Specifies if the last digit is rounded or truncated.
9. Click **Send** to save the changes in the meter.

Display scaling

You can customize the units for metered values shown on the display and webpages.

You can configure the units for voltage, current, power and energy values shown on your meter's display and webpages from their default units, and you can set the resolution for the meter's display. To identify which values will have the modified units, refer to the display and web units information in your meter's Modbus map, available from www.schneider-electric.com.

Configuring display units scaling using ION Setup

You can customize the units for metered values shown on the display and webpages using ION Setup.

Configuring display units scaling is an advanced procedure that requires in-depth knowledge of your meter, its underlying architecture, and the system in which it is installed.

To identify which values will have the modified units, refer to the display and web units information in your meter's Modbus map, available from www.schneider-electric.com.

NOTE: Custom units and resolution settings are automatically adjusted for current and voltage values to help prevent your meter's display from showing incorrect zero values.

1. Start ION Setup.
2. Connect to your meter in advanced mode.
3. Navigate to the Display Options Modules folder and double-click on the module in the righthand pane.
The **Display Options** screen is displayed.
4. Select the **Setup Registers** tab.
5. Select the display units you want to configure: Voltage Units, Current Units, Power Units or Energy Units. Click **Edit**.
A unit selection screen is displayed.
6. Select the desired units from the dropdown list, and click **OK**.

7. When you have finished configuring the display units, click **Send** to send your changes to the meter and close the **Display Options** screen.

See the ION Reference, available from www.schneider-electric.com, for more information about the Display Options module and your meter's ION architecture.

Remote display troubleshooting icons

Your meter's remote display shows troubleshooting icons in addition to the meter's status LED information.

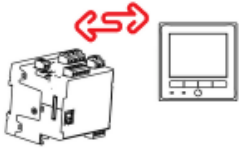
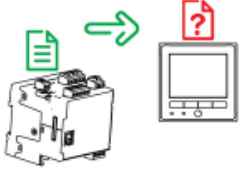
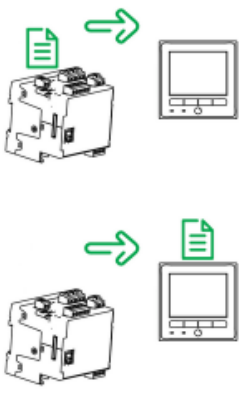
Icon	Description
	<p>Your remote display cannot communicate to your meter. Check the connection between your meter and the display. Check the meter's status LED to confirm that the meter is operating normally.</p>
	<p>Your remote display needs updated firmware for compatibility with your meter.</p>
	<p>Your remote display is undergoing a firmware upgrade. Do not disconnect your remote display from your meter.</p>

Security

Security overview

You can configure standard or advanced security on your meter, as well as optional revenue security.

Your meter comes with configurable security that you can set to either standard or advanced, which helps protect against unauthorized configuration of your meter and access to your meter's data through the meter's display or communications. Your meter has features that allow you to enable/disable Ethernet protocols and port numbers. Your meter also supports revenue locking, which incorporates revenue security on all revenue-related parameters and revenue sealing.

Your meter ships from the factory with standard security enabled.

Standard and advanced security features

Security allows you to configure security features on your meter.

Parameter	Standard/advanced	Details
Meter password	Standard/advanced	The meter's password is used to confirm user access when configuring the meter through the display or over communications. The default meter password is 0 (zero).
Active web server	Standard/advanced	This option allows you to enable or disable your meter's webpages.
Allow web server programming	Standard/advanced	This option allows you to enable or disable the ability to configure your meter using the meter's webpages. NOTE: To enable Allow web server programming , you must have active web server enabled.
Allow Modbus programming	Advanced only	This option can only be enabled in advanced security and is disabled for standard security.
Allow front panel programming	Standard/advanced	This option allows you to enable or disable the ability to configure your device using the display.
Allow broadcasting time synchronization	Advanced only	This option can only be disabled in advanced security and is enabled for standard security.
Protocol lockout	Standard/advanced	This option allows you to configure the number of access attempts before lockout, lockout duration and meter access event priorities.

Advanced security user configuration

Advanced security allows you to configure users with specific access levels and passwords.

Security configuration process

The security configuration process has four basic steps: review security recommendations, set basic security options, configure communications protocol lockout settings, and configure users.

1. Review security recommendations
2. Set basic security options
 - Change the display (front panel) password.
 - Disable broadcasting time synchronization (advanced security only).

- Enable/disable display (front panel) and Webserver programming.
 - Enable/disable Modbus programming (advanced security only).
3. Configure communications protocol lockout options
 - a. Configure protocol-specific settings:
 - Set the number of attempts before the protocol is locked out.
 - Set the session timeout.
 - b. Configure global lockout settings:
 - Enter a lockout duration.
 - Set the priority of meter access events.
 4. Configure users (advanced security only)
 - Determine user access.
 - Set user passwords.

Communications protocol lockout overview

The communications protocol lockout security feature allows you to set the number of invalid login attempts that each user can make using a particular protocol and communications method before being locked out (a user is defined as a user login and password combination).

For protocols that are not session-based (ION), you can configure how often the device registers invalid login attempts by configuring the session timeout. You can also configure the lockout duration for all configurable protocols.

NOTE: If protocol lockout is set to 0 (zero) there is no limit to the number of invalid login attempts and the protocol will never be locked out. However, the invalid login attempt events are recorded if the meter access events are configured to record invalid access attempts.

Session timeout specifies the active duration for a protocol; during this time, repeated invalid login attempts using the same USER/password combination are not registered (repeated invalid attempts with different combinations are still registered). Session timeout only applies to protocols which are not session-based and send credentials with each packet, and should be configured to help prevent accidental lockouts and filling the meter's event log with protocol access events.

Once a user is locked out, the device will not accept login attempts from that user on that protocol and communications method until the lockout duration has passed. Invalid login attempts accumulate until the user has completed a valid login or been locked out. For example, once USER01 has been locked out using ION over Ethernet, USER01 cannot access the device using ION over Ethernet until the lockout duration has passed, even if USER01 enters the correct password. However, if the user enters the correct USER/password combination before being locked out, the invalid attempt counter is reset to zero. Even if the user is locked out using ION over Ethernet, that user can still access the device by entering the correct USER/password combination over a different protocol and communications method (for example, connecting to the device's RS-485 serial port using Modbus protocol).

Related Topics

- Configuring standard security using ION Setup

Security recommendations and best practices

Recommended security configuration

There are recommended security configuration settings to help improve security on your meter.

- Ensure that your meter requires a password for configuration through the display or communications.
- Configure the protocol lockouts to help minimize access to your meter.
- Enable advanced security on your meter.
 - Configure users and passwords to help minimize access to your meter.
- Save a copy of your meter's ION Setup security configuration (*.scf) file in a secure location for future reference or troubleshooting. Your meter's security configuration file can be loaded onto other meters of the same type to configure their security settings.

Password best practices

There are recommended password best practices to help improve security on your meter.

- Change your meter's display (front panel) password from the default value.
- Make your meter's display and user-specific passwords as complex as possible.

NOTE: Make sure that the user password you enter is compatible with the software used to communicate with your device.

- Schedule regular changes to your meter's display and user passwords.
- Record your meter's display and user passwords in a secure location.

If your meter's user access information is lost, you must return the meter to the factory, where your meter is reset to its factory defaults and all logged data is lost.

NOTICE

DATA LOSS

Record your device's user and password information in a secure location.

Failure to follow these instructions can result in equipment damage.

Additional security recommendations

There are additional security recommendations to help improve security on your meter.

- Disable communications for all unused Ethernet network protocols.
- For the highest level of security, use a revenue-locked meter with advanced security enabled and configured for minimum access.
- Save a copy of your meter's security configuration (*.scf) file in a secure location for future reference or troubleshooting. Your meter's security configuration file can be loaded onto other meters of the same type to configure their security settings.
- Set your meter's time synchronization source to a secure communications port, and disable time synchronization on all other ports.

Related Topics

- Protocols, ports and connections

Password setup

It is strongly recommended that you change your meter's display (front panel) password from the default value of 0 (zero).

If your meter's user access information is lost, you must return the meter to the factory, where your meter is reset to its factory defaults and all logged data is lost.

NOTICE

DATA LOSS

Record your device's user and password information in a secure location.

Failure to follow these instructions can result in equipment damage.

Screen title	Parameter	Values	Description
Password Setup	Password	0 to 99999999	Sets the password that must be entered in order to configure parameters using the meter's display NOTE: This is also the password used to access the meter's webpages when standard security is enabled

Changing your meter's display password using the display

You can change your display password using your meter's display.

NOTE: The display password is also used as the webpage password if standard security is enabled.

1. Go to **Setup Menu > Password Setup**.
2. Configure your meter's display password.

Configuring standard security using ION Setup

You can fully configure standard and advanced security on your meter using ION Setup.

In order to change security settings, you must be logged into ION Setup with an appropriate ION Setup user level. You must also have the appropriate meter-level security access to configure meter security.

1. Start ION Setup.
2. Open the Setup Assistant for your meter.
3. Navigate to **Security**. Select Security Mode and click **Edit**. The open dialog box appears.
4. Select the appropriate security configuration file (*.scf) to configure your meter:
 - Standard: allows you to configure basic security and communications protocol lockout.
 - Advanced: includes the standard security features and adds user access/password security settings.
5. The standard options or advanced options configuration screen appears. Configure the security parameters as required, some parameters can only be configured using advanced security.
Click **Next** to configure protocol access information. The protocol lockout screen is displayed.
6. In the protocol lockout screen select the protocols that you want to be protected by the protocol lockout function. Select each protocol and click **Edit** to configure the protocol-specific parameters.
7. Enter the lockout duration (in minutes).
8. Click **Events** to configure user access event priorities. The Event Priorities screen appears.
9. Configure the user access event priorities.

10. If you have selected standard security, click **Finish**. You are prompted to save your security configuration to a file which can be loaded onto other meters.

NOTE: If you chose to save your security file, enter a descriptive name and click **Save**. It is recommended that you do not overwrite the default security files.

If you have selected advanced security, click **Next** to configure user access and passwords.

Security parameters available using ION Setup

Parameter	Standard/advanced	Details
Meter password	Standard/advanced	Default meter password is 0 (zero).
Active web server	Standard/advanced	This option allows you to enable or disable your meter's webpages.
Allow web server programming	Standard/advanced	This option allows you to enable or disable the ability to configure your meter using the meter's webpages. NOTE: To enable allow web server programming, you must have active web server enabled.
Allow Modbus programming	Advanced only	This option can only be enabled in advanced security and is disabled for standard security.
Allow front panel programming	Standard/advanced	This option allows you to enable or disable the ability to configure your device using the display.
Allow broadcasting time synchronization	Advanced only	This option can only be disabled in advanced security and is enabled for standard security.

Protocol-specific security parameters available using ION Setup

Parameter	Values	Description
Protocol lockout	0 - 255	The number of invalid login attempts before access is denied. If protocol lockout = 0, there is no limit to the number of invalid login attempts and the protocol will never be locked out.
Session timeout	1 - 43200 minutes (30 days)	The interval between access checks for non-session based protocols.

Related Topics

- Configuring network communications using ION Setup
- Recommended security configuration

Configuring users and passwords using ION Setup (advanced security only)

Use ION Setup to configure users and passwords.

In order to change security settings, you must be logged into ION Setup with an appropriate ION Setup user level. You must also have the appropriate meter-level security access to configure meter security.

You must have configured the standard security settings on your meter using ION Setup.

This task assumes that you are in the user configuration screen in the security wizard in ION Setup.

1. In the user/passwords screen, select (check) the user that you want to configure to view the user access options.
2. Select the appropriate values to configure the user's access.
Some access levels require that multiple access options be selected.
3. Select the user and click **Password**. The password entry screen appears.

4. Enter the desired password and click **OK**.
5. Continue configuring user access and passwords for each unique user of the meter.

NOTE: Select **Show password when user selected** to display the password associated with that user. This feature is intended to help ensure that the correct password is entered for each user.

6. Click **Finish** to save your security configuration to the meter. You are prompted to save your security configuration to a file which can be loaded onto other meters.

NOTE: If you chose to save your security file, enter a descriptive name and click **Save**. It is recommended that you do not overwrite the default security files.

Access	Description
Time sync	The user can set the meter's time and time synchronization parameters.
Read	The user can view all parameters except the security configuration.
Peak demand reset	The user can reset peak demand values.
Test mode	The user can put the meter into test mode (not applicable to all devices).
Full meter config	The user can configure all aspects of the meter except demand resets, test mode or security.
Security config	The user can configure security.

Loading an existing security configuration file (.scf) using ION Setup

You can load an existing security configuration file (*.scf) onto your meter using ION Setup.

The *.scf file can be a configuration for either standard or advanced security and must be from the same model of meter.

In order to change security settings, you must be logged into ION Setup with an appropriate ION Setup user level. You must also have the appropriate meter-level security access to configure meter security.

1. Start ION Setup.
2. Open the Setup Assistant for your meter.
3. Navigate to **Security**. Select **Security Mode** and click **Send**. The **Open** dialog box appears.
4. Navigate to the location of the *.scf file you want to load onto your meter. Select the *.scf file and click **Open**. The *.scf file is loaded onto your meter.

Communications

Communications overview

Your meter supports several different protocols over its Ethernet and serial connections.

Your meter’s default protocol implementation meets the needs of most systems with only basic configuration. You can customize these implementations to meet your specific needs; these are advanced procedures that require an understanding of your meter’s architecture, the supported protocols, and the communications network and power system that your meter is connected to.

Configuring communications using the display

You can configure your meter’s basic communications settings using the display.

Before configuring Ethernet parameters, make sure you obtain your meter’s IP address and other network information from your network administrator or IT department.

Before configuring serial parameters, make sure you have a unique unit ID for your meter and know the serial network settings (protocol, baud rate, parity and stop bits).

1. Go to **Setup Menu > Communications Setup > IP Address Setup**.
2. Configure your meter’s IP Address and other network information as required.
NOTE: Your meter’s default IP address is 169.254.0.10
3. Press the down button to access the next screen of meter communications settings and configure as required.

Ethernet

Ethernet communications connections

The meter supports a single IP address on both of its two physical Ethernet connections.

You cannot connect your meter to two different Ethernet networks.

Your device’s second Ethernet port acts as an Ethernet switch to help simplify network connections and reduce installation time and costs, by having shorter Ethernet cable runs between devices without needing additional Ethernet routers or repeaters. Your Ethernet connection source should be installed in a location that helps minimize the overall Ethernet cable routing length and complexity of your network.

Each of your device’s Ethernet ports has full transmit/receive bandwidth: this means they do not split the signal, so connecting both of your device’s Ethernet ports should not impact your communications speed.

Ethernet LED behavior

Your meter has two LEDs that indicate the status of its Ethernet communications.

Link (data rate)	On: valid Ethernet connection • Yellow: data rate is 10 Mbps • Green: data rate is 100 Mbps
Act (activity)	Flashing green: data is being transferred

Ethernet configuration

In order to use Ethernet communications, you must configure your device's IP address; you must also configure the subnet and gateway information if required by your network.

NOTE: For meters that do not have a display, you must configure each one separately in order to set a unique IP address for each device.

You need to enter network information for any Ethernet servers used by the device.

NOTE: Contact your network system administrator for your IP address and other Ethernet network configuration values.

Configure your device's Ethernet settings by using the display or directly connecting to your meter and using a web browser to access the device's webpages. Modify your meter's Ethernet settings to those provided by your network system administrator before connecting the device to your local area network (LAN).

After the meter's Ethernet port is configured and connected to the LAN, you can use ION Setup to configure other meter setup parameters.

Protocols, ports and connections

The Ethernet protocols supported by your device allow simultaneous connections through the IP service ports.

Protocol	Port (default)	Number of connections
ION	7700	8 ¹
DNP	20000	
Modbus TCP	502	
Modbus RTU over Ethernet	7701	
Modbus TCP (dedicated)	502	32
EtherGate	7801	1
FTP	21 (20)	2
Webserver (HTTP) ²	80	10
SNMP	161	N/A
SMTP server (email) outgoing only	25	1
NTP	123	1
IEC 61850	102	4

¹These 8 simultaneous connections can be used by ION, Modbus TCP, Modbus RTU over Ethernet, or DNP. You can have a maximum of 3 DNP connections.

²This is used for the meter's webpages.

By enabling or disabling TCP/IP protocols, you can control whether or not your meter accepts new socket connection requests from the TCP/IP protocols supported by the meter. Changing settings does not impact existing connections. Depending on the protocol, you can also change the port number.

If you configure communications so that you cannot communicate to and configure your meter, you must return the meter to the factory, where your meter is reset to its factory defaults and all logged data is lost.

NOTICE

DATA LOSS

Ensure you maintain sufficient access to communicate to and configure your device.

Failure to follow these instructions may result in data loss.

Related Topics

- Configuring network communications using ION Setup
- Supported protocols

Ethernet topologies

When wiring your meter’s Ethernet communications, it is recommended to only use straight-line topology.

If local network loop or ring Ethernet topologies are required, you must enable RSTP (rapid spanning tree protocol) for your meter’s Ethernet communications to function.

Self-discovery over Ethernet

Your meter supports DPWS (devices profile for web services) which allows for self-discovery of the meter when directly connected on IPv6 local area networks.

When you connect your meter directly to your computer, your meter automatically appears on the network. By default, the meter is named <meter type>_<last six digits of MAC address>.

NOTE: You do not need to configure your meter’s IP address for self-discovery over Ethernet; an IPv6 address is automatically generated from your meter’s MAC address and self-discovery takes place over IPv6.

Double-clicking the meter’s network icon takes you to the meter’s webpages, where you can view data and perform basic meter configuration.

NOTE: For self-discovery, the meter must be connected directly to the computer using only a cable or switches, and not by a router.

For example, a meter with a MAC address of 0060784173393 appears on the network as <meter type>_173393.

Configuring network communications using ION Setup

You can configure your device’s Ethernet settings using ION Setup.

If you are connected to your device over Ethernet, changing Ethernet configuration parameters without another method of configuration enabled may cause loss of communications with your device and render it inoperable. In this case a factory reconfiguration of your device is required, which resets your device to its factory defaults and all logged data is lost.

<i>NOTICE</i>
<p>DATA LOSS</p> <p>Record your device's user and password information in a secure location.</p> <p>Failure to follow these instructions can result in equipment damage.</p>

1. Start ION Setup.
2. Open the **Setup Assistant** for your device.
3. Select **Communications > Network Settings** and click the **TCP/IP** tab.

4. Select a setting and then click **Edit**. Configure the settings (for example, IP address, subnet or gateway) to match your communications system.

Parameter	Value	Description
Ethernet device name	configurable	This name is associated with your meter when using DPWS. By default, it is the meter type and the last 6 characters of its MAC address.
Enable IPv6	Yes/no	Specifies if IPv6 is enabled or disabled.
IP address	Contact your local network administrator for parameter values.	The Internet protocol address of your device.
SubnetMask		The Ethernet IP subnetwork address of your network.
Gateway		The Ethernet IP gateway address of your network.
Rx timeout	configurable	Specifies the number of seconds the meter waits for communication acknowledgments.
Modbus TCP Idle Timeout	configurable	Specify number of seconds the meter waits before disconnecting an idle Modbus TCP connection.
Modbus Gateway	Disabled/COM1	Specify the port on which Modbus Gateway sends/ receives Modbus TCP requests. NOTE: For Modbus gateway to function properly, the serial port protocol must be set to Modbus Master.
MAC address	Read-only	The media access control (MAC) address is factory set and is for reference only.

5. Click the **Protocols** tab.
6. Select a protocol and then click **Edit**. Select whether the protocol connection requests are accepted by the meter, and configure the port number. Existing connections are not affected, but any new connections must comply with the meter's latest settings.

NOTE: The protocol port number is not configurable on all protocols.

Related Topics

- Configuring standard security using ION Setup

Serial

Serial communications

The meter supports serial communications through its RS-485, optical and USB ports.

RS-485

In an RS-485 network, there is one master device, typically an Ethernet to RS-485 gateway. It provides the means for RS-485 communications with multiple slave devices (for example, meters). For applications that require only one dedicated computer to communicate with the slave devices, a USB to RS-485 converter can be used to connect to the master device.

Up to 32 devices can be connected on a single RS-485 bus.

Optical

Your meter’s integrated display has an optical port used for communicating with your meter using an optical probe. Your meter’s optical port can also be configured for energy pulsing.

USB

Your meter’s integrated display has a mini-B USB port which is used to configure your meter with a computer running ION Setup.

Serial protocols and ports

Your meter supports serial communications protocols on its RS-485, optical and USB ports.

Protocol	RS-485	Optical	USB
ION	Y	Y	Y
Modbus RTU	Y	Y	—
Modbus Master	Y	—	—
DNP 3.0	Y	Y	—
EtherGate	Y	—	—
GPS: Truetime/Datum ¹	Y	—	—
GPS: Arbiter ¹	Y	—	—
GPS: Arbiter-Vorne ¹	Y	—	—
Infrared I/O ²	—	Y	—
¹ These protocol settings are used for connecting to a GPS receiver communicating in serial ASCII format. ² This protocol setting is used to convert the optical port from communications to energy pulsing.			

Related Topics

- Supported protocols

Communications setup

You can configure your meter’s basic communications parameters using the display.

IP address setup

Parameter	Values	Description
IP Address	Contact your local network administrator for parameter values	Sets the IP address for the meter NOTE: Your meter’s default IP address is 169.254.0.10
SubnetMask		Use if subnetting applies to your network
Gateway		Use in networks with multiple segments
MAC Address	Not configurable	Your meter’s media access control (MAC) address.

Ethernet setup

Parameter	Values	Description
Enable RSTP	Yes, No	Specifies if rapid spanning tree protocol (RSTP) is enabled NOTE: If local network loop or ring Ethernet topologies are required, you must enable RSTP for your meter's Ethernet communications to function
Enable ION Over TCP	Yes, No	Specifies if ION protocol communications are enabled over Ethernet
Enable Web Server	Yes, No	Specifies if the meter's webpages are enabled for viewing

DNS setup

Parameter	Values	Description
Primary DNS	As defined by your network's system administrator	Sets the address for the primary DNS server that is configured to resolve domain names
Secondary DNS	As defined by your network's system administrator	Sets the address for the secondary DNS server that is configured to resolve domain names

COM1 (RS-485) setup

Parameter	Values	Description
Protocol	ION, Modbus RTU, Modbus Master, DNP v3.00, EtherGate, GPS: Truetime/Datum, GPS: Arbiter, GPS: Arbiter-Vorne, Factory	Sets the communications protocol for your meter's RS-485 port
Baud Rate	2400, 4800, 9600, 19200, 38400, 57600, 115200	Sets the data rate, in bits per second
RTS Delay	0.000 to 1.000	Sets the transmit delay in seconds
Unit ID	1 to 9999	Sets the meter's unique ID on the RS-485 network NOTE: Modbus serial device range 0 to 247
Serial Port	8N1, 8N2, 8E1, 8E2, 8O1, 8O2	Sets the parity and stop bits for the port
RS485 Bias	Off, On	Turns on biasing when mastering devices over the RS-485 port

COM2 (optical port) setup

NOTE: The optical port is available on meters with an integrated display.

Parameter	Values	Description
Protocol	ION, Modbus RTU, DNP V3.00, Factory, Infrared I/O	Sets the communications protocol for your meter's optical port NOTE: Set the protocol to Infrared I/O to make your meter's optical port available for LED energy pulsing then configure the LED energy pulsing parameters.
Baud Rate	2400, 4800, 9600, 19200	Sets the data rate, in bits per second
RTS Delay	0 to 1	Sets the transmit delay in seconds

Parameter	Values	Description
Unit ID	1 to 9999	Sets the meter's unique ID on the meter's optical port NOTE: Modbus serial device range 0 to 247
Serial Port	8N1, 8N2, 8E1, 8E2, 8O1, 8O2	Sets the parity and stop bits for the port

COM3 (micro-USB port) setup

NOTE: The micro-USB port is available on meters with an integrated display.

Parameter	Values	Description
Protocol	ION, Factory	Sets the communications protocol for your meter's optical port
Unit ID	1 to 9999	Sets the meter's unique ID on the meter's optical port

NTP address

Parameter	Values	Description
NTP Server	As defined by your network's system administrator	Specifies the IP address of the SNTP or NTP server used by the meter for time synchronization

SMTP address

Parameter	Values	Description
SMTP Server	As defined by your network's system administrator	Specifies the IP address of the SMTP server used by the meter for sending email

RS-485 configuration

Before connecting your device to the RS-485 bus, use the meter's display, webpages or ION Setup to configure your meter's default RS-485 settings.

Your meter has one RS-485 connection.

Your meter must have a unique unit identifier (address) and have the following settings match the rest of the devices on the RS-485 bus:

- Protocol
- Baud rate
- Parity and stop bits

You can configure the following settings to help optimize communications performance:

- RTS delay
- RS-485 bias

You can use a communications converter (USB to RS-485 or RS-232 to RS-485) or an Ethernet gateway device to connect to your meter.

RS-485 Bias

You can use the RS-485 bias setting to fine tune communications.

Turn on the RS-485 bias when the meter is acting as a master over RS-485 communications and turn off the RS-485 bias when the meter is acting as a slave. You can configure RS-485 biasing through the meter's display or ION Setup.

RS-485 and gateway communications

Your meter can act as a gateway from the devices on the RS-485 bus to another communications port on the meter.

For example, you can configure your meter as an Ethernet gateway, which lets you communicate through the meter's Ethernet port to the serial devices connected to the meter's RS-485 port using the ION protocol (EtherGate) or Modbus protocol (Modbus gateway).

Related Topics

- Configuring an EtherGate gateway using ION Setup
- Configuring a Modbus gateway using ION Setup

Optical port overview

Your meter has an optical port on the integrated display.

Your meter's optical port is designed to accept ANSI Type 2 magnetic couplers. It provides serial communications for real-time measurements to a portable computer, and can be used for meter configuration via the ION, Modbus RTU, DNP 3.0 or Factory protocols. It can also be configured for energy pulsing.

You can configure the optical port settings using the display or ION Setup.

Optical probe recommendations

You can use an optical probe to communicate to your meter through the optical port located on the integrated display.

Terminal programs

If you are using a terminal program, it must allow you to control the DTR line to the off state (-5V), for example, Tera Term 4.59 or later.

Using the Abacus Electrics A6Z-P-D09F optical probe

The A6Z-P-D09F derives all necessary power from the host computer serial port. See the Abacus Electronics website for detailed information.

Ensure the 9-pin female "D" connector is connected to the appropriate COM port on your laptop or handheld device.

This probe is compatible with ION Setup operating at its default settings, including:

- DTR: Disabled (or forced off)
- RTS: Toggle

Using the Abacus Electrics A9U-P-U04M optical probe (USB)

The A9U-P-U04M is a USB 1.1 and USB 2.0 compliant device that derives all necessary power from the host computer and is for use with Windows 98/2000/XP only. See the Abacus Electronics website for detailed information.

This probe comes supplied with "virtual serial port" drivers. Follow the manufacturer's instructions when installing virtual serial port driver software. Ensure the USB connector is connected to the appropriate COM port on your laptop or handheld device.

This probe is compatible with ION Setup operating at its default settings, including:

- DTR: Disabled (or forced off)
- RTS: Toggle

Configuring your meter's optical port using the display

You can configure your meter's optical port settings using the display.

1. Access your meter's setup menu.
2. Navigate to **Communications Setup**.
3. Scroll to the **COM2 Setup** screen.
4. Configure the optical port's serial communication settings as required.
Set the **Protocol** to **InfraredI/O** to set the optical port to energy pulsing instead of serial communications.

Configuring your meter with ION Setup using the optical port

Connect an optical probe from a computer running ION Setup to the optical port on the meter's integrated display in order to configure your meter using ION Setup.

You need an optical probe to connect your computer to your meter. Your meter's optical port protocol must be set to **ION**.

1. Connect your optical probe to your computer and to the meter's optical port.
2. Start ION Setup.
3. Select **Single ION device configuration mode** and click **OK**.
The **Connection Type** screen is displayed.
4. Select **Serial**.
5. Select the port connected to the meter from the **Comm Port** list.
Your computer's physical USB ports end with COM, and you may have to try different ports to select the port connected to your meter.
6. Click **Settings** and select the **Timings** tab.
7. Set **RTS Control** to **Toggle**.
8. Set **DTR** to **Force Off**.
9. Click **OK**.
10. In the **Connection Type** screen, click **OK** to connect to your meter.
ION Setup attempts to connect to your meter. When connected, the setup assistant for your meter is displayed.

Configuring your meter's optical port using ION Setup

You can configure the optical port on your meter's integrated display for serial communications or energy pulsing.

The optical port is only available on meters with an integrated display.

1. Start ION Setup.
2. Open the Setup Assistant for your meter.
3. Navigate to **Communications > Serial Settings**.
4. Select the tab corresponding to the optical port (Com2).
5. Highlight the parameters and click **Edit** to configure the optical port's parameters as required.

- Click **OK** to set the parameter on the meter.

Optical port parameters available using ION Setup

Parameter	Description
Protocol	Sets the communications protocol for your meter's optical port. NOTE: To configure your optical port for energy pulsing, set the Protocol to Infrared I/O . Go to LED Pulsing > Optical Port to set the optical port's energy pulsing parameters.
Unit ID	Sets the meter's unique ID on the meter's optical port NOTE: Modbus serial device range 0 to 247
Baud Rate	Sets the data rate, in bits per second
RX Timeout	Sets the timeout for receiving an entire message from a device, in seconds NOTE: This parameter only applies to ION and DNP protocols; other protocols use a default setting that cannot be configured
Serial Port	Sets the parity and stop bits for the port

Configuring your meter with ION Setup over USB

Connect a USB cable from a computer running ION Setup to the mini-B USB on the meter's integrated display in order to configure your meter using ION Setup.

You need a USB to mini-B USB cable to connect your computer to the meter's mini-B USB port. The protocol of your meter's mini-B USB port must be set to **ION**.

- Connect your computer's USB port to your meter's mini-B USB port using the cable.
- Start ION Setup.
- Select **Single ION device configuration mode** and click **OK**. The **Connection Type** screen is displayed.
- Select **Serial**. From the **Comm Port** list select the USB port connected to the meter. Baud rate and parity settings are not used for USB communications and do not need to be configured. Your computer's physical USB ports end with COM, and you may have to try different ports to select the port connected to your meter.
- Click **OK**. ION Setup attempts to connect to your meter. When connected, the setup assistant for your meter is displayed.

NOTE: You may need to load the driver for your computer to recognize the meter as a USB device and connect using ION Setup. The USB driver is located in the Drivers folder where the ION Setup program files are installed. Refer to Microsoft help for instructions on loading USB drivers.

ION

ION is the native protocol and architecture of your meter.

The basic building blocks of ION architecture are the ION modules, each of which is specialized to perform a specific task and contains data and instructions on how to manage that data. ION modules are combined (linked) together to create the meter's functions and features. ION modules that are linked together to perform a specialized task are called a framework, such as the Power Quality framework. These different functional frameworks are then grouped together to define the entire meter, and are collectively referred to as the device template.

Your meter ships with a default device template which provides extensive capabilities. You can also configure your meter's template to modify your meter's existing functions or to create new functions.

See the ION Reference, available from www.schneider-electric.com for further information about ION architecture and a detailed description of the different ION modules. See the ION Device Template Reference, available from www.schneider-electric.com, for details on the modules and their configuration in your meter's default template.

Modbus

Modbus is a master/slave communications protocol where the master initiates transactions and the slave(s) responds with the requested information or action.

Your device can function as a Modbus slave or Modbus master, depending on how it is configured. Your device comes with Modbus slave functionality configured and ready to use. You can add custom Modbus information to the default Modbus slave data provided by your device.

Key terms

Term	Definition
Modbus gateway	A communications method that lets you communicate through an Ethernet gateway device to a Modbus serial network connected to that device.
Modbus master	A device that issues commands and receives responses from Modbus slave devices. Serial Modbus networks can only have one Modbus master per network.
Modbus RTU	Serial Modbus protocol format; Modbus RTU transmits data using binary. Master and slave devices must use the same format.
Modbus register/address	Identifies the data to read/write. Modbus register maps are available for Modbus slave devices and detail the information available from the slave device. More than one register may be used to store a single value.
Modbus slave	A device that responds to Modbus commands and performs actions or provides information back to the Modbus master. Most Modbus networks contain multiple slave devices.
Modbus TCP	The Ethernet Modbus protocol format.
Modbus unit ID	The identifier for a slave Modbus device.

You can download your device's Modbus map from www.schneider-electric.com and get additional information about the Modbus protocol from www.modbus.org.

Your meter as a Modbus slave on a serial network

Your meter can function as a Modbus slave on a serial network.

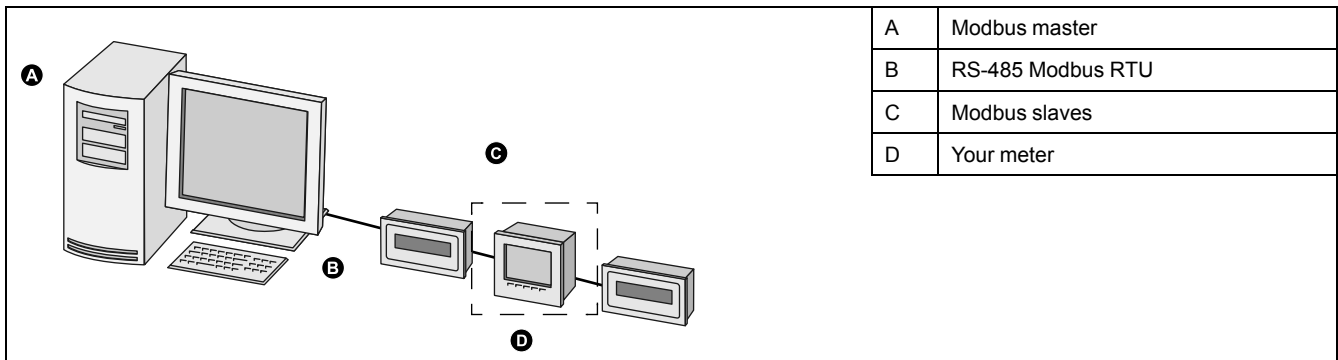

Your meter as a Modbus slave over Ethernet

Your meter can function as a Modbus slave over Ethernet.

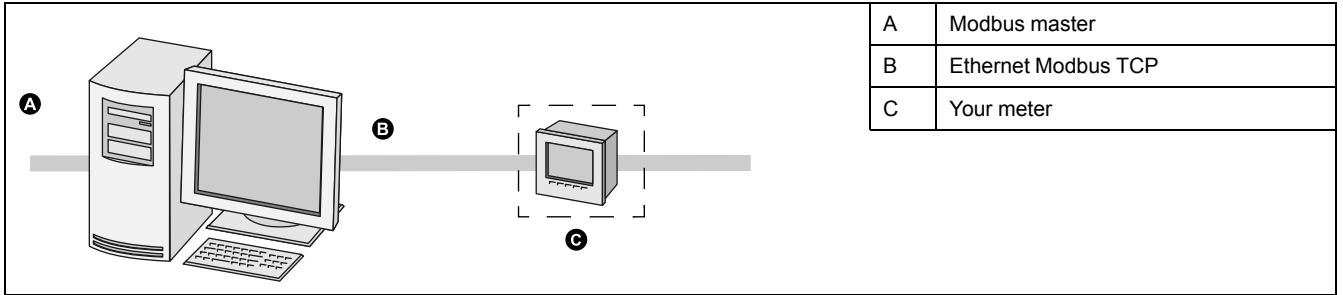

Your meter as a Modbus master with serial Modbus slave devices

Your meter can function as a Modbus master with serial Modbus slave devices.

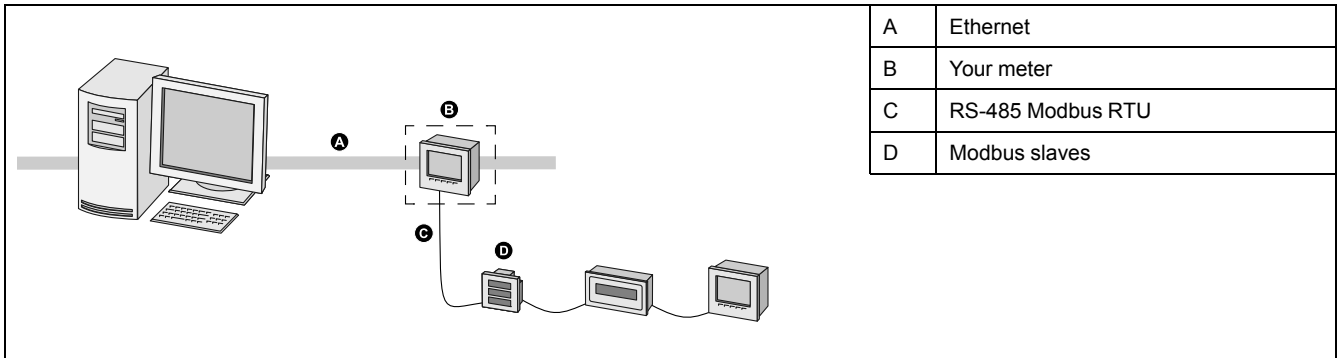

Your meter as a Modbus master with Ethernet Modbus slave devices

Your meter can function as a Modbus master with Ethernet Modbus slave devices.

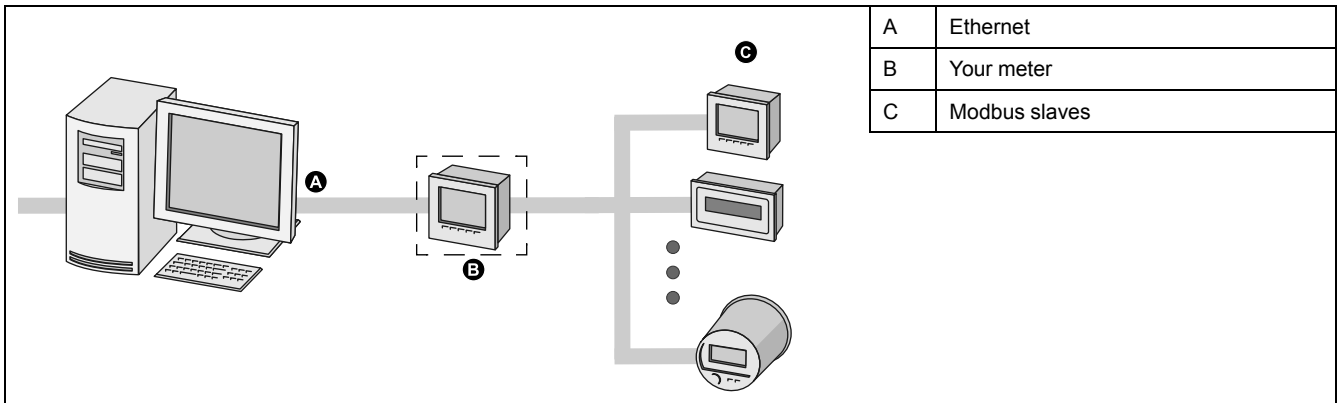

Supported Modbus features

Your meter supports specific Modbus data classes, data formats, function codes and commands.

Modbus data classes

Class	Description
Coils	Digital bits that can be read and written to
Input status	Digital bits that can be read
Input registers	16-bit integers that can be read
Holding registers	16-bit integers that can be read and written to

Modbus data formats

Format	Type	# of Modbus registers used
Unsigned 16-bit	Integer	1
Signed 16-bit	Integer	1
Unsigned 32-bit	Integer	2
Signed 32-bit	Integer	2
Unsigned 32B-M10K	Integer	2
Signed 32B-M10K	Integer	2
IEEE float ¹	Floating point	2
Packed Boolean for inputs	Integer	1
Packed Boolean for coils	Integer	1
Unsigned 16-bit read/write	Integer	1
Signed 64 bit	Integer	4

¹ Meters acting as Modbus masters support two versions of IEEE float with different word orders: high/low = Big Endian, low/high = Little Endian.

16-bit data (one word) is transmitted with most-significant byte first and least-significant byte second.

32-bit data (two words) is transmitted with the most-significant word first and the least-significant word second.

Modbus function codes

Function	Description	Master/slave
1	Read coil status	Master and slave
2	Read input status	Master and slave
3	Read holding registers	Master and slave
4	Read input registers	Master
5	Write to a coil	Master
6	Write to a holding register	Master and slave
15	Write to multiple coils	Master
16	Write to multiple holding registers	Master and slave
17	Report slave ID (serial only)	Master and slave
43 (subcode 14)	Read device identification	Master and slave
100	Read scattered holding registers	Master and slave

Modbus commands

A Modbus master command to unit ID 0 is broadcast (sent to) all Modbus slave devices. The only supported broadcast command is preset multiple registers.

For serial Modbus networks with only one slave device, the master can send commands using the single connection, one-to-one address of unit ID 248, regardless of the slave device's actual unit ID.

Modbus implementation

Your meter's Modbus implementation includes exception codes, invalid register responses, fixed and configurable register maps, and security.

Modbus exception codes

Code	Name	Description
01	Illegal function	The requested command is invalid.
02	Illegal address	This code indicates one of the following: <ul style="list-style-type: none"> The requested address is invalid for that function. The requested address is not within the valid register range for this device. The requested address is protected by device security.
03	Illegal value	This code indicates one of the following: <ul style="list-style-type: none"> The requested value is not allowed for that register in the device. The requested register is part of a multi-word value.

Modbus invalid read registers responses

Invalid type	Read response
Unmapped (unused) ¹ register	0x8000
Reserved ¹ register responses by type	
Signed integer 16-bit	0x8000
Unsigned integer 16-bit	0xFFFF
Signed integer 32-bits	0x80000000
Unsigned integer 32-bits	0xFFFFFFFF
Signed integer 64-bits	0x8000000000000000
Float32	0xFFC00000 (NaN = Not a number)

¹ IRIG-B can only be connected to one of the digital inputs located on the meter base, not an option module. Unmapped (unused) registers are registers that will never be used by the meter, and therefore have no defined format. Reserved registers have a defined format and are intended for use by the meter, its options or its variants.

Modbus invalid write registers response

If the meter receives a write command to a Modbus register address that does not have a register mapped, the meter does not respond. No data is written or stored, and the meter does not send back a rejection to the request.

If the meter receives a write command to a read-only Modbus register address, exception code 3 (illegal value) is returned.

Fixed and configurable Modbus map

Your device has a fixed (static) register map for meter data and a flexible, user-configured register map.

Modbus security

Your meter's onboard security options include Modbus-specific settings. These security settings may need to be configured in order to write Modbus data to the meter.

Modbus best practices for serial

In order for your meter to operate as a serial Modbus device, you must complete some prerequisite configuration.

Prerequisite	Description
Wiring	The device's serial connection must be wired correctly. The Modbus slave devices must have communications wiring to the Modbus master.
Protocol	Slave: for your meter to be a serial Modbus slave, the meter's protocol must be set to Modbus RTU. Master and slave devices must use the same format. Master: for your meter to be a serial Modbus master, the meter's protocol must be set to Modbus Master.
Baud rate	The baud rate must be the same for all devices on the serial Modbus network.
Stop bits and parity	The communication stop bits and parity (for example, 8N1) must be the same for all devices on the serial Modbus network.
Unit ID	Each device on the serial Modbus network must have a unique unit ID (also called the device address).

Modbus best practices for Ethernet

In order for your meter to operate as an Ethernet Modbus device, you must complete some prerequisite configuration.

NOTE: You do not need to perform any Modbus-specific configuration for your meter to function as a Modbus slave device over Ethernet.

Prerequisite	Description
Ethernet	All devices must have a working Ethernet connection.
IP address	All devices must have a unique IP address.
Port	All devices must be communicating over Ethernet port 502 for Modbus TCP.

NOTE: Devices supporting multiple simultaneous Modbus TCP connections can have communications delays. Adjust your network timeout settings to accommodate this.

Modbus master best practices

In order for your meter to operate as a Modbus master, you must complete some prerequisite configuration.

NOTE: These settings are required in addition to the serial or Ethernet Modbus prerequisites.

Prerequisite	Description
Modbus slave devices	All Modbus slave devices must be communicating and appropriately configured.
Protocol	<ul style="list-style-type: none"> Modbus mastering serial devices: the master's serial port protocol must be set to Modbus master. Modbus mastering Ethernet devices: the master must be communicating to the slave devices over Ethernet port 502. <p>NOTE: Having more than one Modbus master on a serial Modbus network may cause communication conflicts.</p>
Mastered devices	The Modbus master device must have the slave device information entered for mastering.

Modbus map

Your meter's default Modbus register information (map) is available for download from www.schneider-electric.com.

The Modbus register information includes:

- registers and mapped values
- formats and scaling

- additional details where applicable

NOTE: Your meter’s Modbus registers are specified differently than previous devices using ION architecture. If you are configuring Modbus slave information on your meter, confirm you are using the appropriate Modbus register addressing. Refer to your meter’s Modbus map for more information.

Your meter has a fixed (static) register map which contains the most common metering values. This map is defined by a series of Data Mapping modules, which also determine the values shown on your device’s display and webpages. The Data Mapping modules are named based on the type of information they map to Modbus:

Data Mapping module	Description
Data Mapping Dmd Modules	Maps kW, kVA and kVAR demand data such as kW sd del (sliding demand kilowatts delivered) as well as current demand such as I a sd (sliding demand phase A current).
Data Mapping Egy Modules	Maps kWh, kVAh and kVARh delivered and received data, including conditional, quadrant and incremental energies.
Data Mapping EN Modules	Maps present interval EN50160 power quality compliance data.
Data Mapping EN Prev Modules	Maps previous interval EN50160 power quality compliance data.
Data Mapping I/O Modules	Maps input metering data, alarms, resets and reset counts.
Data Mapping Meas Modules	Maps measured data from the standard and high-speed Power Meter module. The Cfg Modbus Map Enable setup register may exist in this module.
Data Mapping PQ Modules	Maps power quality data such as Crest Factor, K Factor and total harmonic distortion, including IEC 61000-4-30 power quality compliance data.
Data Mapping Stats Modules	Maps statistical low, mean and high data values, such as I a mean (phase A current average value).
Data Mapping TOU Modules	Maps time-of-use (TOU) data, such as seasons, rates, and per-season demand such as kW sd rec A (sliding demand kilowatts received in season A).

You can add extra Modbus information or duplicate information that is already in the fixed map to different Modbus registers using Modbus Slave modules.

See the ION Reference available from www.schneider-electric.com for detailed information about Data Mapping modules and Modbus Slave modules.

Related Topics

- Configuring custom Modbus data using ION Setup

Configuring your meter for Modbus using the display

You can use the display to configure your meter as a Modbus slave or partially configure your meter for Modbus mastering.

NOTE: Your meter’s communications must be wired and configured before you begin this procedure.

Your meter does not require any Modbus-specific configuration to act as a Modbus slave device over Ethernet.

1. Navigate to **Setup Menu > Communications Setup** and select the serial communications setup screen.

2. Configure the serial port's Modbus parameters as required.

Parameter	Setting
Protocol	Modbus RTU or Modbus master
RS485 Bias	<ul style="list-style-type: none"> • Off if the meter is a Modbus slave • On if the meter is a Modbus master

3. Configure the meter's other serial port parameters as required.

For Modbus master, you must add the Modbus slave devices using ION Setup.

Related Topics

- Meter setup using your meter's display

Configuring your meter as a Modbus slave using ION Setup

You can configure your meter as a Modbus slave using ION Setup.

Your meter's serial connection must be wired and configured correctly. The same mode of serial communication must be used for all devices on the network.

Your meter does not require any Modbus-specific configuration to act as a Modbus slave device over Ethernet.

1. Start ION Setup.
2. Open the Setup Assistant for your meter.
3. Navigate to **Communications > Serial settings**. Select the tab for the serial port you want to configure.
4. Highlight the parameter and click **Edit** to configure the serial port's Modbus parameters as required.

Parameter	Setting
Protocol	Modbus RTU or Modbus master
RS485 bias	<ul style="list-style-type: none"> • Off if the meter is a Modbus slave • On if the meter is a Modubs master

5. Configure the meter's other serial port parameters as required.

See your device's Modbus map, available from www.schneider-electric.com for Modbus register information.

Configuring custom Modbus data using ION Setup

You can add custom data to your meter's default Modbus map, completely customize your meter's Modbus map, or revert your meter's Modbus map back to its default configuration using ION Setup.

You can download your meter's Modbus map information from www.schneider-electric.com.

1. Start ION Setup.
2. Open the Setup Assistant for your meter.
3. Navigate to **Communications > 3rd party protocols** and click on the **Modbus Slave** tab.
The name of the meter's current Modbus map is displayed, along with the quantity of custom registers and their start and end addresses.
4. Select the map name and click **Edit**.
The **Modbus Slave Mode Setup** screen is displayed.

5. Select your meter’s method of Modbus slave mapping. If you select **Default** or **Disabled**, click **Finish** to configure your meter and return to the Setup Assistant, otherwise select **Next** to access the **Modbus Slave Map Setup** screen.

Option	Description
Default	Sets your meter to use the default Modbus map. Any custom Modbus slave data is removed. NOTE: You can download your meter’s Modbus map information from www.schneider-electric.com .
Modified	Add Modbus information in addition to the meter’s default Modbus map.
Custom	Removes the meter’s default Modbus map so that all registers are available so you can create a completely custom Modbus map. NOTE: Use this option if you want to make your meter’s Modbus map identical to a device that it is replacing, for example in a retrofit application.
Disabled	Removes your meter’s Modbus data map. Modbus functions are unaffected but no meter Modbus data is available.

6. In the **Modbus Slave Map Setup** screen, you can modify parameters by clicking **Edit**, or add parameters by clicking **Add**. The **Modbus Register** screen is displayed.
7. Configure the Modbus register information and click **OK** to return to the **Modbus Slave Map Setup** screen.
 - a. **Source:** click **Select** and chose a source from the **Parameter Selection** screen. Select **Show all available registers** to see a complete list of the parameters available on your meter. Click **OK**.
 - b. **Address:** enter the Modbus address that will hold the Source data.
NOTE: If you hover your mouse over the Address field, a tooltip indicates the Modbus function code and start address to send for retrieving the data.
 - c. **Format:** select the Modbus data format from the list.
 - d. **Scaling:** select the scaling value from the list, or select **Custom** and click **Scales** to configure custom scaling.
8. In the **Modbus Slave Map Setup** screen you can click **Delete** to remove a Modbus register, **Set Name** to create a new name for the set of additional data mapped to Modbus, or **Save As** to save the additional data you have mapped to Modbus as a separate file.
9. Click **Finish** to complete your meter’s Modbus slave configuration and return to the Setup Assistant.

Configuring your meter as a Modbus master using ION Setup

You can configure your device to Modbus master slave devices over serial or Ethernet.

Make sure your master and slave devices have the prerequisite communications wiring and configuration before configuring your meter as a Modbus master.

NOTE: Devices supporting multiple simultaneous Modbus TCP connections can have communications delays. Adjust your network timeout settings to accommodate this.

The meter as a Modbus master over TCP/IP attempts to communicate with a slave device for up to 100 seconds (as per the RFC1122 standard) before moving on to the next slave device.

1. Start ION Setup.
2. Open the Setup Assistant for your meter.
3. Navigate to **Communications > 3rd Party Protocols** and click on the **Modbus Master** tab.

4. Click **Add** to add a Modbus slave device. The Modbus Device dialog appears.
5. Enter the Modbus slave information:
 - Enter the Modbus slave device’s name and a label suffix (if applicable).
 - Select the device type of the slave device from **Device Type**.
 - Enter the unit ID of the Modbus slave device into **Slave ID**.
 - Select the serial or TCP connection from **Connected via**. This is the connection from the Modbus master to the slave device.
6. Click **Connections**. The Modbus Master Connections dialog appears.
7. Select the tab that corresponds to the connection you are configuring (for example, if you selected TCP Connection 1 from **Connected via**, select the TCP 1 tab) and configure it based on the connection type.

Connection type	Configuration
Serial connection	Select the serial communications port that is connected to the Modbus slave devices from the Assigned Port list.
TCP connection	Enter the IP address of the Modbus slave device, making sure that the IP port is set to 502.

8. Click **OK** to return to the Modbus Device dialog.
9. Click **OK** to add the slave device. The device now appears on the list. Repeat these steps to add all of your Modbus slave devices.

Related Topics

- Modbus

Ethernet gateway

Ethernet gateway is a communications method that allows you to communicate through a gateway device to a serial network.

When a meter with gateway capabilities is installed on an Ethernet network, a master device (such as an energy management system) can communicate through the gateway meter to a serial network of devices connected to the gateway meter’s serial port(s). The maximum number of devices on the serial network is determined by the limitations of the gateway meter’s serial port.

There are two types of Ethernet gateways that you can configure on your meter:

- EtherGate: a single TCP connection communicates through the gateway meter to a serial network of devices.
- Modbus gateway: up to a maximum of 32 Modbus master TCP connections communicate through the gateway meter to a serial network of Modbus devices.

Related Topics

- Specifications

EtherGate

The meter can function as an Ethernet gateway (EtherGate).

EtherGate is a protocol-agnostic communications method that lets you communicate through a gateway meter to a serial network of devices letting ION or other RTU over TCP data pass through the gateway meter to other networks, including third party systems. When a meter installed on the Ethernet network has EtherGate enabled, a master device (such as an energy management system) can communicate through the gateway meter to a serial network of devices wired to the gateway meter’s COM port. You must create an additional communications connection to the gateway meter in order to read its information.

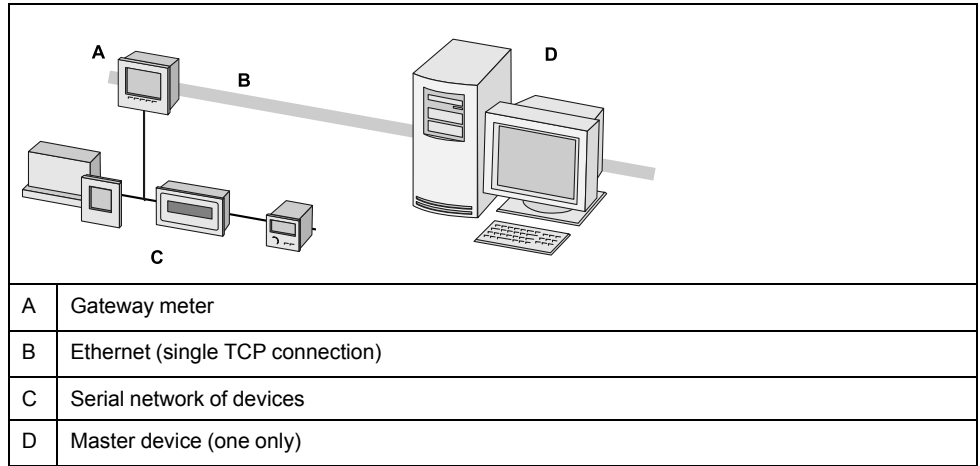

For EtherGate, you must install the serial devices, configure them and connect them to your Ethernet-connected gateway meter. Ensure that each serial device is configured with the same protocol and baud rate and has a unique unit ID. Configure the gateway meter’s serial port to use the EtherGate protocol, create the EtherGate site in ION Setup or an energy management system, and add the serial devices to the EtherGate site.

NOTE: EtherGate supports only one master device.

Related Topics

- Configuring an EtherGate gateway using ION Setup

Modbus Ethernet gateway

The meter’s Ethernet gateway feature extends the meter’s functionality by allowing Ethernet access to serial devices connected to the meter’s RS-485 serial communications port.

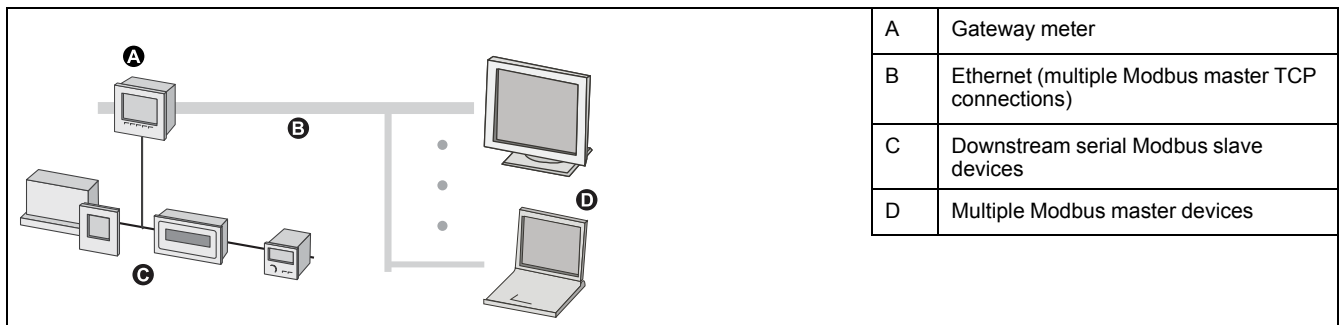

A Modbus master device (such as an energy management system) can communicate through the gateway meter to a serial network of devices connected to the gateway meter’s serial port(s). The meter receives Modbus TCP/IP data on TCP port 502, translates it to Modbus RTU then forwards it to the addressed slave device.

This functionality allows the use of monitoring software to access information from slave devices for data collection, trending, alarm/event management, analysis, and other functions.

Configuring EtherGate using the display

Use the meter’s display to configure a serial port to use the EtherGate protocol.

1. Navigate to **Setup Menu > Communications Setup** and go to the serial communications setup screen.
2. Set the serial port’s protocol to EtherGate. Configure the other serial port parameters as required.

Configuring a Modbus gateway using ION Setup

You can configure Modbus gateway on your meter using ION Setup.

Before you begin, make sure you have completed the following tasks:

- Confirm the serial network of devices are wired and configured to have the same baud rate, serial port settings (for example, 8N1), and protocol (Modbus).
- Confirm each serial device has a unique unit identifier.
- Confirm the serial network of devices are connected to the gateway meter's serial communication port.
- Confirm your gateway meter is communicating over Ethernet.

1. Start ION Setup.
2. Open the Setup Assistant for your meter.
3. Navigate to **Communications > Serial settings** and select the tab for the communications port that the serial network is connected to.
4. Select **Protocol** and click **Edit**.
The protocol selection screen appears.
5. Set the protocol to **Modbus Master**.
6. Navigate to **Communications > Network settings** and select the **TCP/IP** tab.
7. Select **Modbus Gateway** and click **Edit**.
The Modbus gateway selection screen is displayed.
8. Select the communications port that the serial network is connected to (and you just set to use the Modbus master protocol) and click **OK**. The Modbus gateway connection is created.
9. Create an Ethernet gateway site to access the serial network of devices through your gateway meter.

Configuring an EtherGate gateway using ION Setup

You can configure EtherGate on your meter using ION Setup.

Before you begin, make sure you have completed the following tasks:

- Confirm the serial network of devices are wired and configured to have the same baud rate, serial port settings (for example, 8N1), and protocol (ION).
- Confirm each serial device has a unique unit identifier.
- Confirm the serial network of devices are connected to the gateway meter's serial communication port.
- Confirm your gateway meter is communicating over Ethernet.

1. Start ION Setup.
2. Open the Setup Assistant for your meter.
3. Navigate to **Communications > Serial settings** and select the tab for the communications port that the serial network is connected to.
4. Select **Protocol** and click **Edit**. The protocol selection screen appears.
5. Set the protocol to **EtherGate**.
6. Create an Ethernet gateway site to access the serial network of devices through your gateway meter.

Creating an Ethernet gateway site using ION Setup

You can create an EtherGate or Modbus gateway site in ION Setup to view serial devices connected to your meter when it is functioning as an Ethernet gateway.

You must have Ethernet gateway communications configured and your gateway and serial devices connected and communicating.

1. Start ION Setup.
2. Right-click on your workstation icon and select **Insert Item**.
The **New Network Item** dialog appears.
3. Select **Site** and click **OK**.
The **New Site** dialog appears.
4. Select the **General** tab and configure the site.

Parameter	Values/Options	Description
Name	-	Ethernet gateway site name
Comm Link	Ethernet	Ethernet communications
Ethernet options	Gateway	Ethernet gateway communications
Gateway Info: IP Addr	—	IP address of the Ethernet gateway meter
Gateway Info: Port	7801, 502	<ul style="list-style-type: none"> • 7801 for EtherGate • 502 for Modbus gateway

5. Click **OK** to create the site.
6. Right-click on your newly created site and select **Insert Item**.
The **New Network Item** dialog appears.
7. Make sure your newly created Ethernet gateway site is selected in **Attach to**.
8. Select **Device** and click **OK**.
The **New Device** dialog appears.
9. Enter the details of your serial device. Click **OK** to add the serial device to your Ethernet gateway site.
10. Repeat for all the serial devices on the gateway meter.

NOTE: Use a separate standard Ethernet connection in ION Setup to connect to and read data from your Ethernet gateway meter.

FTP

Your meter has an internal FTP server that you can use to load files, such as custom webpages, and upgrade your meter and meter accessories.

File transfer protocol (FTP) is a standard, client-server network protocol used to transfer files over TCP (Ethernet) networks.

FTP memory allocation

Your meter’s FTP memory usage changes when you copy a file to the meter’s internal FTP site or modify a feature that uses the meter’s FTP site.

If you attempt to load a file onto your meter’s FTP site that is too large, your FTP program displays an error, and you must delete files from your meter’s internal FTP site to free up memory before loading the file.

If you modify a meter feature which uses FTP memory, such as increasing the number of COMTRADE waveform records, the meter checks to confirm sufficient space is available on its internal FTP site before enabling the modified feature. If there is insufficient space, the feature is disabled, and you must delete files from your meter’s FTP site to increase the available space before enabling the feature.

FTP file structure and permissions

Your meter has an FTP folder structure.

- COMTRADE: you can read COMTRADE files from these folders, but you cannot delete or add files to these folders.

- IEC61850: you can add an IEC 61850 configuration (CID) file to this folder to activate the IEC 61850 protocol functions of your meter.
- optionModuleUpg and rmdUpg: you can load firmware update files for your meter’s remote display or option modules into these folders.
- documents: this folder is intended for user storage. You can read, write and delete any type of files in this folder.
- web: this folder is where the meter’s default webpages are stored and where you can add custom webpages to the meter by copying them into the appropriate subfolders.

FTP filename requirements

FTP filenames are limited to standard ASCII characters.

This means that they cannot contain a blank space, quotation marks or \, /, *, ?, < or >, and are limited to 68 characters in length, including the file extension. The “/” character is only used as part of the FTP file directory information.

Accessing your meter’s FTP server

You must have FTP software such as Filezilla, WinSCP or Windows Explorer running on a Windows-based machine to transfer files to and from your meter’s internal FTP server.

1. Start your FTP software.
2. Connect to your meter via FTP by entering your meter’s IP address. Depending on your FTP software and meter security settings, you may be prompted for login credentials.

NOTE: With standard meter security (no user configured), enter login credentials of 8000 and the meter password to connect to the meter. For advanced meter security, enter a valid user and password.

3. Navigate to the appropriate folder on your meter.
4. Close your FTP software to disconnect from the meter. The FTP connection automatically disconnects once the FTP timeout period has elapsed.

SNMP

Simple Network Management Protocol (SNMP)

Your meter supports SNMP once you have enabled SNMP on your meter. You need to upload the meter’s MIB file (available from www.schneider-electric.com) into the NMS managing your meter.

Simple Network Management Protocol (SNMP) is part of the Transmission Control Protocol/Internet Protocol (TCP/IP) protocol suite. SNMP is an application layer protocol that enables the exchange of network management information between devices, allowing you to manage network performance and to identify and solve problems on networks with devices of various types.

SNMP configuration assumes that you have an advanced understanding of SNMP and the communications network and power system that your meter is connected to.

Key terms

Term	Definition
Agent	Software resident on the managed device which interfaces between the device and the NMS.
Managed device	Your meter in the SNMP network.

Term	Definition
Community name/string	A text string that helps authenticate requests between the managed device and the NMS.
Managed object	Any parameter referenced in the MIB file.
MIB	A management information base which organizes the OIDs in a hierarchical tree.
NMS	A network management station, manager or client that executes applications to monitor and control devices. An NMS must have the standard and custom MIB files and SNMP manager software.
OID	An object identifier that uniquely identifies and labels a managed object in the MIB.
Trap receiver	An NMS that is configured to receive traps and whose IP address is an SNMP trap destination.

The meter in an SNMP system

Your meter is a managed device with an SNMP agent in an SNMP network.

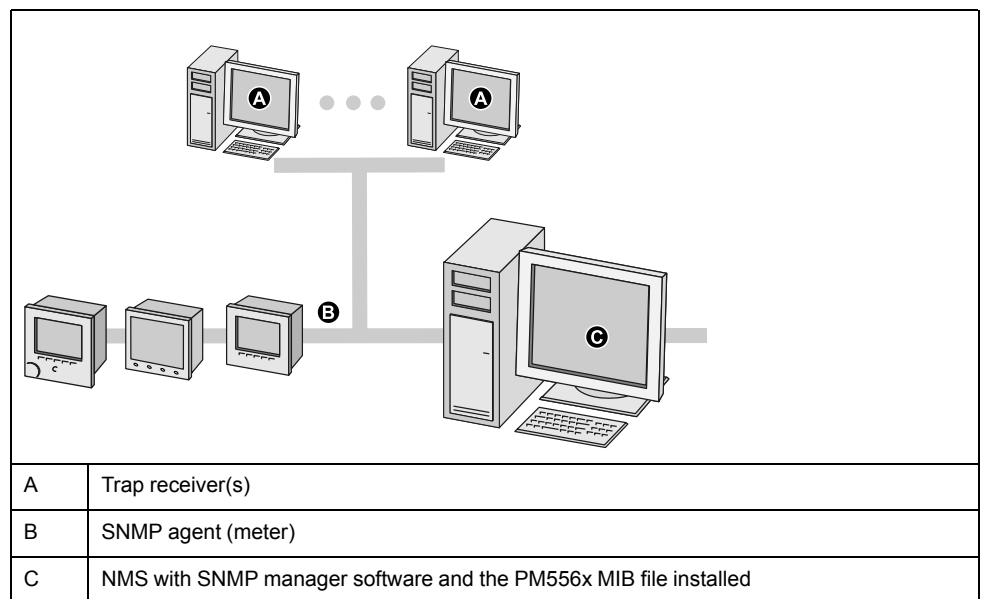

NOTE: The NMS computer can also function as a trap receiver.

SNMP implementation

MIB files

Your meter is compliant with MIB-II as defined by the standard MIB file RFC 1213.

SNMP requires that you load your meter's ION MIB file (available for download from www.schneider-electric.com) into the NMS.

You must install RFC 1213, which is required to read basic network information for the meter (for example, TCP/IP traffic or number of packets received), if it is not included with your SNMP manager software.

Community strings

A community string is a text string which acts to help authenticate requests from the NMS to your meter.

There are two community strings on your meter:

- **Read Only Community:** this community string is used by SNMP get (read-only) requests. The read only community string's initial factory-set value is **public**.

- Read Write Community: this community string is used by SNMP set (read/write) requests. The read write community string's initial factory-set value is **private**.

NOTE: You can also use the read write community string for SNMP get (read-only) requests.

If your meter receives an incorrect community string, it generates an AuthenticationFailure trap.

System strings

A system string is a text string which can be configured to provide information about your meter.

There are three system strings on your meter:

- System contact: enter the name of the SNMP system administrator.
- System name: enter a descriptive name for your meter.
- System location: enter a description of your meter's location.

SNMP trapping

SNMP trapping allows your meter's agent to notify the NMS of events with an unsolicited SNMP message (a "trap" of the meter's alarm event).

You can enter up to four IP addresses for SNMP trap notification for generic and enterprise-specific traps. For enterprise traps, you must also define the number of events or maximum time delay before SNMP traps are sent to the NMS.

SNMP trapping is only supported on SNMP v2.

SNMP trapping implementation

Generic SNMP traps supported by your meter are:

- Coldstart: the meter (SNMP agent) is starting.
- Linkup: the SNMP agent is enabled.
- AuthenticationFailure: the meter (SNMP agent) has received an incorrect community value.

Enterprise-specific SNMP traps supported by your meter are:

- Low: trap of events with a low event priority.
- Medium: trap of events with a medium event priority.
- High: trap of events with a high event priority.

Trap	Event priority range
Low	64–127
Medium	128–191
High	192–255

NOTE: The number of events or maximum time delay settings only apply to enterprise SNMP traps.

See the ION Reference, available from www.schneider-electric.com, for detailed information on the SNMP Mapping, SNMP Options and Alarm Options modules.

Related Topics

- Configuring SNMP using ION Setup
- Configuring SNMP using your meter’s webpages

Default SNMP mapping

Enabling SNMP provides SNMP access to the meter values linked to the SNMP Mapping module.

You can configure the SNMP Mapping module to link to different meter values. By default, the following meter values are linked to the SNMP Mapping module:

I a	kVAR tot	VII ca	VIn avg	Ib mean	kW sd mx del-rec
I b	kVA tot	VII avg	Freq	Ic mx	kW sd del
I c	PF sign tot	VIn a	Ia mx	Ic mean	kW sd rec
I avg	VII ab	VIn b	Ia mean	kW sd mx del	kW sd del-rec
kW tot	VII bc	VIn c	Ib mx	kW sd mx rec	kVAR sd mx del
kVAR sd mx rec	kVAR sd mx del-rec	kVAR sd del	kVAR sd rec	kVAR sd del-rec	kVA sd mx del
kVA sd mx rec	kVA sd mx del-rec	kVA sd del	kVA sd rec	kVA sd del-rec	kWh del
kWh rec	kWh del-rec	kVARh del	kVARh rec	kVARh del-rec	kVAh del
kVAh rec	kVAh del-rec				

The following meter information is always provided by default and cannot be configured:

Voltsmode	Model number
Serial number	Device name
Firmware version	MIB version

If you change your meter’s default values you must modify the custom MIB file to reflect the new values.

Changing your meter’s default SNMP configuration assumes that you have an advanced understanding of ION architecture, SNMP, and the communications network and power system that your meter is connected to.

See the ION Reference, available from www.schneider-electric.com, for detailed information on the SNMP Mapping module.

Configuring your SNMP MIB file

You must configure your MIB file if you have modified the default SNMP information provided by the meter in order for the MIB file labels to reflect the modified values.

Download the ION MIB file from www.schneider-electric.com.

NOTE: You should only configure the variable name and description. Changing other fields in your MIB file may cause the client software to report problems or return errors when trying to retrieve or view parameters.

The variable name must conform to the following rules:

- The first character must be a letter.
- The first character must be lower case.
- The name must not contain any special characters such as *, ?, &.
- The name must not contain spaces.

1. Open your meter’s MIB file in a text editing program (such as Notepad).
2. Update the variable name and description so they match the meter values connected to the SNMP Mapping module.
3. Save your meter’s MIB file. Make sure you keep the original file extension of . MIB.

This example shows an original and an updated OID entry in an MIB file, where the default meter value of voltage line-to-neutral phase A is modified in the meter’s SNMP Mapping module and is now connected to voltage line-to-neutral phase C.

Original OID entry
VIn_a OBJECT-TYPE SYNTAX DisplayString (SIZE (0.. 255)) ACCESS read-only STATUS mandatory DESCRIPTION "Host Meter Voltage Line A to Neutral Units = V (Volts)" ::= { Schneider Electric 34 }

You must update the variable name and description to match the meter values connected to the SNMP Mapping module:

Value	Original	Updated
Variable name	VIn_a	VIn_c
Description	"Host Meter Voltage Line A to Neutral Units = V (Volts)" ::= { Schneider Electric 34 }	Host Meter Voltage Line C to Neutral Units = V (Volts)" ::= { Schneider Electric 34 }

The SNMP client software reads the original and updated file as follows:

Original	Updated
variable name: VIn_a Description: "SNM1 Input 1 - Voltage (line-to-neutral) phase A"	variable name: VIn_c Description: "SNM1 Input 1 - Voltage (line-to-neutral) phase C"

Configuring SNMP using ION Setup

You can enable SNMP and configure SNMP trapping using ION Setup.

You must download the ION MIB file from www.schneider-electric.com

1. Start ION Setup.
2. Open the Setup Assistant for your meter.
3. Navigate to **Communications > Network Settings** and select the **SNMP** tab.

- Configure your meter's SNMP parameters by selecting the parameter and clicking **Edit**. Click **OK** in the editing screen to set the parameter value.

Parameter	Description
Enable SNMP	Enables or disables SNMP on your meter.
Enable Traps	Enables or disables SNMP trapping on your meter.
Trap Rcvr Addr1 — Trap Recvr Add4	Enter up to four trap receiver IP addresses where trap messages will be sent.
Read only community	Enter the community string used for SNMP get (read-only) requests.
Read write community	Enter the community string used for SNMP set (read/write) requests. NOTE: You can use the read/write community string for SNMP get (read-only) requests.
System contact	Enter the name of your SNMP system administrator.
System name	Enter a descriptive name for your meter.
System location	Enter your meter's location.

- Review the rest of the SNMP information and modify if necessary.

Related Topics

- Simple Network Management Protocol (SNMP)

Configuring SNMP using your meter's webpages

You can configure SNMP trapping using your meter's webpages.

You must download the ION MIB file from www.schneider-electric.com.

- Connect to your meter's webpages.
- Go to **Setup > SNMP Parameters**.

3. Configure your meter's SNMP parameters by selecting the parameter value.

Parameter	Range	Description
Enable SNMP .	Yes/no	Enables or disables SNMP on your meter.
SNMP Port Number	161 (default)	Enter your meter's SNMP port number
System contact	—	Enter the name of your SNMP system administrator.
System name	—	Enter a descriptive name for your meter.
System location	—	Enter your meter's location.
Read-only Community Name	—	Enter the community string used for SNMP get (read-only) requests.
Read-write Community Name	—	Enter the community string used for SNMP set (read/write) requests. NOTE: You can use the read/write community string for SNMP get (read-only) requests.
Enable SNMP Traps	Enable/disable	Enables or disables SNMP trapping on your meter.
Enable High Priority Alarms	Yes/no	Enables trapping of events that create high priority alarms.
Enable Med Priority Alarms	Yes/no	Enables trapping of events that create medium priority alarms.
Enable Low Priority Alarms	Yes/no	Enables trapping of events that create low priority alarms.
Report Buffer Size	1 - 30	Enter the maximum number of trap messages to be stored before the trap messages are sent. Traps are sent when the number of trap messages is equal to or greater than this value.
Report Hold Time	1 - 300 seconds	Enter the maximum duration for trap messages to be held. Trap messages are sent when the time after a trap event has occurred is equal to or greater than this value.
Trap Rcvr1 Addr - Trap Rcvr4 Addr	—	Enter up to four trap receiver IP addresses, where trap messages will be sent.

4. Click **Apply** to configure the meter's SNMP parameters.

IEC 61850

IEC 61850 is an Ethernet-based protocol designed for electrical substations.

It is a standardized method of communications, developed to support integrated systems composed of multi-vendor, self-describing IEDs (intelligent electronic devices) that are networked together.

Your meter can be integrated into an IEC 61850 system as an IED (or server) supporting concurrent IEC 61850 client connections and an FTP connection (used for transferring data or configuration files).

You can go to the IEC (International Electrotechnical Commission) website at www.iec.ch for information about the IEC 61850 protocol. For more information on how IEC 61850 is implemented on your meter, see the *IEC 61850 and ION Technology* protocol document.

IEC 61850 implementation

Your meter comes configured with a default set of meter data available to IEC 61850.

This default set of meter data is used in the default data sets and reports in the ICD file(s) available for download from www.schneider-electric.com.

NOTE: Select the ICD file that matches your meter's option module configuration.

You must load a valid IEC 61850 configuration (CID) file into the meter's internal FTP site in order to activate the IEC 61850 features of your meter.

NOTE: Your meter can have only one IEC 61850 configuration (CID) file loaded onto its internal FTP storage. If additional CID files are loaded, IEC 61850 functions are deactivated until the additional files are removed.

You can load the IEC 61850 configuration file and configure the IEC 61850 custom modules using ION Setup.

Related Topics

- FTP
- Specifications

Loading an IEC 61850 configuration file using ION Setup

You can load an IEC 61850 configuration (CID) file using ION Setup over an Ethernet connection.

You must have:

- The IEC 61850 configuration file stored in a location accessible by ION Setup. The configuration file is created by customizing the IEC 61850 device (ICD) file, which can be downloaded from www.schneider-electric.com.
- FTP access to your meter from the computer running ION Setup.

NOTE: Your meter can have only one IEC 61850 configuration (CID) file loaded onto its internal FTP site. If additional CID files are loaded, IEC 61850 functions are deactivated until the additional files are removed.

1. Start ION Setup.
2. Open the Setup Assistant for your meter.
3. Navigate to **Communications > 3rd Party Protocols** and select the **IEC 61850** tab.
4. Highlight a parameter and click **Upload**. Navigate to where you stored your meter's CID file, select the file, and click **Open**.

Your meter reviews the CID file to determine if it is valid. This process may take several minutes.

The CID status indicates whether the meter has received and validated an IEC 61850 CID file and is operating as an IEC 61850 server.

Configuring additional data for IEC 61850 using ION Setup

You can map additional data to IEC 61850 using ION Setup.

You must have a valid IEC 61850 configuration file loaded onto your meter for IEC 61850 functionality, but it is not necessary for configuring additional data.

NOTE: You can configure additional data at any time, whether or not IEC 61850 is operating on your meter.

1. Start ION Setup.
2. Open the Setup Assistant for your meter.
3. Navigate to **Communications > 3rd Party Protocols** and select the **IEC 61850** tab.
4. Select the information type that corresponds to the type of meter information that you want to add to your IEC 61850 data. Select analog for numeric information and digital for boolean or binary information. Click **Edit**. The custom configuration screen is displayed.
5. Select the desired meter value from those available. If the value you want is not shown, select **Show all available registers**.
6. Select an IEC 61850 leaf to associate with the meter data, and click **>>** to map the value. Click **<<** to unmap values. Click **OK** to send and save your changes to the meter.

Configuring digital outputs for IEC 61850 control using ION Setup

You can configure your digital outputs so that they can be used for non-critical control via IEC 61850.

Your meter has a comprehensive default implementation of IEC 61850 which meets the needs of most systems with only basic configuration. You can customize this implementation so that IEC 61850 can be used to control your meter's digital outputs; this is an advanced procedure that requires in-depth knowledge of your meter, its underlying architecture, and the system in which it is installed.

⚠ WARNING

UNINTENDED OPERATION

Do not use this device for critical control or protection applications where human or equipment safety relies on the operation of the control circuit.

Failure to follow these instructions can result in death, serious injury, or equipment damage.

1. Start ION Setup.
2. Connect to your meter in advanced mode.
3. Navigate to the GGIO Onboard folder and double-click on the module in the righthand pane.
4. Select the **Setup Registers** tab.
5. Select the *SPCS Control Mode* register that corresponds to the digital output you want to control through IEC 61850 and click **Edit**. A dialog appears.
6. Select IEC 61850 CTLVAL from the dropdown list and click **OK**.
7. Select the **Inputs** tab.
8. Select the digital output Status register for the digital output that you want to control through IEC 61850. Click **Delete**.

NOTE: This digital input register must be deleted in order to prevent a circular reference that will cause the affected modules to go offline.

9. Click **Send** to send your changes to the meter.
10. Select the **Setup Registers** tab and confirm that the Digital Output module's setup registers are appropriately configured.
11. Select the **Inputs** tab.
12. Select the *Source* register and click **Edit**.
13. Navigate to the IEC 61850 GGIO Onboard folder and select the *SPCS.stVal* output register that corresponds to the digital output.
14. Click **OK** and **Send** to save your changes to the meter.

See the ION Reference, available from www.schneider-electric.com, for information about the IEC 61850 GGIO and Digital output modules.

COMTRADE

Your meter can automatically generate COMTRADE files and store them on the meter's internal FTP site.

COMTRADE stands for COMmon format for TRANsient Data Exchange defined by IEC 60255-24 edition 2001-05, and defines a common format for power quality event (disturbance) data in order to simplify retrieval, analysis and exchange of disturbance data between multiple sources and vendors.

The format of your meter's COMTRADE files is as defined by IEC 60255-24 edition 2001-05.

COMTRADE is configured as part of the default waveform recording but not enabled from the factory.

COMTRADE can be used in conjunction with IEC 61850.

NOTE: If you are generating COMTRADE waveform information, the associated waveform recorders cannot be modified unless COMTRADE is disabled. If the waveform recorders are not configured identically, COMTRADE waveform information will not be generated.

See the *COMTRADE and ION technology* technical note, available from www.schneider-electric.com, for detailed information about COMTRADE file formats and implementation.

Related Topics

- FTP

Configuring COMTRADE waveform recording using ION Setup

You can enable and configure COMTRADE waveform recording using ION Setup.

COMTRADE is configured as part of the default waveform recording but not enabled from the factory.

Your meter's COMTRADE files' format complies with the standard defined by IEC 60255-24 edition 2001-05.

COMTRADE records are stored as read-only files on your meter's internal FTP server, and are deleted when you perform a Master reset of the meter.

NOTE: To configure waveform recording, you must disable COMTRADE, configure waveform recording, and then enable COMTRADE. COMTRADE records are not generated if the waveform recorders have inconsistent settings.

1. Start ION Setup.
2. Open the Setup Assistant for your meter.
3. Navigate to **Power Quality** and click the **COMTRADE**.
4. Configure the COMTRADE parameters:

Parameter	Values	Description
Status	Enabled/ Disabled	Enabled: COMTRADE files are generated. Disabled: COMTRADE files are not generated.
Depth	1 or more	The number of COMTRADE records stored on the meter. <ul style="list-style-type: none"> • By default the oldest COMTRADE record will be overwritten by the newest record. • A message is displayed if the Depth value exceeds the available memory. • A single COMTRADE record uses approximately 45 kB of meter memory.

Downloading COMTRADE files using ION Setup

You can download COMTRADE waveform records from the meter's internal FTP server to another network location using ION Setup.

1. Start ION Setup.
2. Open the Setup Assistant for your meter.
3. Navigate to **Power Quality** and click the **COMTRADE**.
4. Select the status parameter and click **Save**. The **Upload COMTRADE files** screen is displayed.

5. Select the criteria for the COMTRADE files you want to load from your meter's internal FTP site to another network location. Click **OK**.

NOTE: If no COMTRADE files are downloaded, the ION Setup status bar provides a descriptive message.

DNP

Your meter can be integrated into a DNP network as a DNP slave.

The Distributed Network Protocol Version 3.0 (DNP 3.0) is an open protocol used in the electric utility industry for communications and interoperability among substation computers, Remote Terminal Units (RTUs), Intelligent Electronic Devices (IEDs, e.g. meters), and master stations.

DNP supported features and default implementation

Your meter is pre-configured for basic DNP Slave functionality.

Your meter supports a maximum of three concurrent connections (sessions) using the DNP 3.0 protocol; one for each serial port, up to three using Ethernet, or a combination of both. Combinations available depend on the meter's communications options. A session consists of all incoming and outgoing DNP Master/Slave traffic on one of the meter's communications ports.

For serial DNP communications, you must assign the DNP protocol to the appropriate serial communication port on your meter; you do not have to configure your meter's Ethernet port(s).

You can modify your meter's default DNP map using configuration software.

Data can be imported into the meter from a DNP control relay or analog output device. This is an advanced feature intended for users with an in-depth understanding of the DNP 3.0 and ION protocols.

See the online ION Setup help for instructions on connecting to your meter and accessing the Setup Assistant, which can be used to modify your meter's DNP port settings and default DNP map. Go to www.schneider-electric.com to download your meter's DNP 3.0 device profile document for detailed information on your meter's default DNP map and implementation and the *Multiport DNP 3.0 and ION technology* technical note for more information on how your meter supports DNP 3.0.

Time and timekeeping

Time overview

Your meter supports different time types and time synchronization methods to adjust its internal clock.

Your meter's internal clock is used for keeping time, timestamping data and determining intervals for time-based measurements. The meter's clock does not affect externally logged data.

Your meter monitors the passage of time using the frequency of an internal oscillator or the frequency of the line power being measured. You can view your meter's time and date information using the display or through software. To improve your meter clock's accuracy, you can use an external time reference, such as a Global Positioning System (GPS) signal.

Your meter's battery maintains the internal clock when the meter is unpowered.

Your meter displays local time based on the meter's time sync source and settings for timezone and daylight savings time. You can configure your meter's date and time format.

Go to www.schneider-electric.com and download the *Time synchronization and timekeeping* technical note for more information about time formats and settings and the *ION Reference* for a detailed description of the Clock module and its operation.

Time synchronization overview

The time synchronization source and the duration between time synchronization messages determines the accuracy of the meter's clock.

The clock is adjusted by synchronizing the meter's time with another time source. Time synchronization messages can be automatically generated and sent to your meter from your energy management system software or other time source such as an SNTP/NTP server or GPS receiver. You can also manually trigger a time synchronization message from your energy management system or configuration software.

NOTE: To help maintain data integrity, some energy management systems impose a blackout rule where time synchronization messages near energy interval boundaries are ignored.

Supported time synchronization sources

Several time synchronization sources are available to your meter.

- Meter configuration software (ION Setup): Configuration software can manually synchronize the time of your meter based on the clock of the computer running the configuration software. Configuration software synchronization is usually performed when the meter is initially commissioned.
- Energy management system: Energy management systems can synchronize the time of your meter to be consistent with other meters on the network.
- Simple Network Time Protocol (SNTP): SNTP can synchronize the time of your meter up to ± 1 second of other meters on an Ethernet network. For SNTP time synchronization, your meter must be connected to an Ethernet network that has an active SNTP server and be configured with the server's information.
- GPS receiver (IRIG-B): A GPS receiver using IRIG-B can synchronize the time of a meter up to ± 1 ms of Coordinated Universal Time (UTC). A dedicated serial network is required to implement a GPS scheme. For IRIG-B, one of your meter's digital inputs must be connected to the IRIG-B network, and the digital

input must be configured for IRIG-B time synchronization in addition to configuring your meter’s clock.

NOTE: Use the digital inputs located on the meter base for IRIG-B time synchronization and other high-accuracy applications.

- GPS over serial: A GPS receiver can synchronize the time of a meter up to ± 1 ms of Coordinated Universal Time (UTC). For GPS over serial, your meter’s serial port must be connected to a GPS receiver, and the serial port communications must be configured with the correct protocol setting.
- Network Time Protocol (NTP): NTP can typically synchronize the time of a meter to ± 10 to 100 ms, depending on network configuration. To implement NTP time synchronization, your meter must be connected to an Ethernet network that has an active NTP server and be configured with the server’s information.

Configuring time information using your meter’s display

Use the meter’s display to configure a variety of time parameters.

1. Go to **Setup Menu > Date/Time/Clock Setup > Date & Time Setup**.
2. Configure your time and date formats, time zone offset, and daylight savings time offset. Press the down button to access the **Clock Setup** screen.
3. Configure the clock and time synchronization source, and the time synchronization time format.

Date/Time/Clock setup

You can configure your meter’s date, time and clock parameters using the display.

Date & time setup

Parameter	Values	Description
Time Format	12 H, 24 H	Specifies how the time is displayed
Date Format	MM/DD/YYYY, DD/MM/YYYY, YYYY/MM/DD	Specifies how the date is displayed
TZ Offset	-12:00:00 to 12:00:00	Sets the time zone of the meter’s location, relative to UTC
DST Offset	-3:00:00 to 3:00:00	Sets the daylight savings time offset of the meter’s location

Clock setup

Parameter	Values	Description
Clock Source	Internal, Line Freq, COMM	Specifies the time synchronization source
Time Sync Source	COM1, Ethernet, Ethernet - ION, Ethernet - DNP, IRIG-B	Specifies the port to receive time synchronization signals
Time Sync Type	UTC, Local	Specifies whether time synchronization signals are received in local time or UTC

Configuring time and time synchronization using ION Setup

You can set the time and date and configure the time synchronization settings using ION Setup.

NOTE: The clock screen is where you set the start day of the week for the time of use feature.

NOTE: You must manually adjust the date and time information if the device is installed in a different time zone location from the computer running ION Setup.

1. Start ION Setup.
2. Open the Setup Assistant for your device.
3. Navigate to **Clock** and select the **Timezone** tab.
4. Select any parameter and click **TimeSync** to synchronize your device's date and time with the computer that is running ION Setup.
5. Click the **DST Settings** tab to modify your meter's daylight savings time start and end dates, if required.
6. Select the parameter that you want to configure and click **Edit**. Enter the password if prompted.

Parameter	Value	Description
Timezone	–	Sets the timezone based on the timezones available from the computer's operating system. NOTE: This is also where you can synchronize your meter's DST settings with the computer's.
Time sync type	Local time or UTC	Specifies the time format of the time sync message: <ul style="list-style-type: none"> • UTC: Coordinated Universal time: for the purposes of meter configuration, it is equivalent to Greenwich Mean Time (GMT). • Local time: the local time, with DST and timezone information applied.
Time sync source	COM1, Ethernet, Ethernet - ION, Ethernet - DNP, IRIG-B	Sets which device port accepts time synchronization messages. Time synchronization messages on other ports are ignored.
Clock Source	Internal, Line frequency, COMM	Sets the source for the clock: <ul style="list-style-type: none"> • Internal: the meter's internal clock. • Line frequency: the frequency of the measured power system as the clock source. • COMM: the meter's communication port (used by the GPS time sync source).
DST Offset	Numeric Bounded Format/Elapsed Interval Format	Specifies the amount of time the meter clock is moved forward when entering Daylight Savings. A value of zero disables this feature and clock does not adjust for DST.
Start of the Week	Monday - Sunday	Specifies the start day of the week used for Trending and Forecasting. NOTE: Changing the start day of the week clears all trending and forecasting data.

For SNTP/NTP time synchronization, you must set the **Time sync type** to **UTC** and the **Time sync source** to **Ethernet**.

For GPS/IRIG-B time synchronization, you must set the **Time sync source** to **IRIGB** and the **Clock Source** to **COMM**.

7. For SNTP/NTP time synchronization, you must also enter the following information under **Communications > Network Settings > NTP**:

Parameter	Value	Description
Enable NTP Time Sync	NTP, SNTP, No	NTP: specifies NTP time synchronization. SNTP: specifies SNTP time synchronization. NOTE: SNTP is recommended for revenue-related applications. No: neither NTP nor SNTP time synchronization are used.
NTP Time Sync Interval	Numeric value or elapsed interval value	Specifies how often the meter synchronizes over SNTP. NOTE: This parameter is not used for NTP.
NTP Event Logging Threshold (NTP only)	1000 to 1000000	Specifies the minimum time difference (in milliseconds) for a time synchronization to be logged as an event. This parameter can be configured to help prevent the meter's event log from being flooded with time synchronization events.
NTP Server	Server IP address or domain name	Specifies the IP address (or fully qualified domain name if DNS is active) of the SNTP or NTP server.

8. For serial GPS time synchronization, you must also enter the following information under **Communications > Serial** settings:

Parameter	Description
Protocol	Select the GPS setting that matches your GPS receiver.
Baud rate	The recommended baud rate for GPS time synchronization is 9600 bps.
Serial port	The recommended stop bits/parity for GPS time synchronization is 8N1.

Maintenance

Firmware and templates

Firmware and template overview

You can load different firmware versions and templates onto your meter.

Firmware is your meter's operating system that enables the functions of your meter. Your meter's template defines the meter's features such as its power measurement and analyzing functionality. Your meter ships from the factory with a default template, or you can customize your meter's template to create features specific to your meter's application. You can save your customized template and upload it to other meters of the same type.

You can view your meter's firmware version on your meter's display, webpages and through ION Setup.

You can upgrade your meter's firmware and template using ION Setup. Firmware updates and new factory templates are available for download from www.schneider-electric.com.

Firmware overview

Firmware is your meter's operating system.

When new firmware is available for your meter, you can upgrade to the latest version to get the added features and functionality. The firmware version loaded on your meter is shown on your meter's display. You can use ION Setup to upgrade the firmware on your meter.

The meter's firmware includes a digital signature, which helps ensure the firmware's authenticity.

You must load a meter template as part of the firmware upgrade process. You can save your meter's existing template before performing a firmware upgrade and then reload it back onto the meter if you do not want to change your meter's template.

Your meter's remote display and option modules use firmware information from the meter, but they may also need to have their internal firmware updated to support new or improved features. To load and update to your meter's remote display firmware, you need to copy the file to your meter's internal FTP server. You can download firmware files from www.schneider-electric.com.

See the online ION Setup help, available from www.schneider-electric.com, for more information about downloading, saving and loading your meter's template.

Typical workflows

To update your meter to the latest available firmware and factory template:

- Download the latest firmware and template for your meter.
- Load the firmware onto your meter; the firmware upgrade process includes upgrading the meter template.

To take an existing meter out of service and replace it with a new meter:

- Save the template from the existing meter
- Load the existing meter's template onto the new meter; the new meter will now have the customized features from the existing meter.

To update your meter's firmware without updating your meter's template:

- Save your meter's template.
- Download the latest firmware.

- Load the firmware onto your meter. When prompted for a template file, select the template you saved from your meter.

To update the firmware on your meter's remote display:

- Download the display firmware.
- Load the firmware onto the meter's internal FTP site using either an FTP program or ION Setup. The results of the firmware update are stored in the meter's event log.

To update the firmware on your meter's option module(s):

- Download the option module firmware; make sure that the firmware matches the option module type.
- Load the firmware onto the meter's internal FTP site using either an FTP program or ION Setup.
- Power cycle or perform an option bus reset to start the option module firmware

NOTE: If the meter is power cycled or an option module reset is performed while there are option module firmware upgrade files loaded on the meter's FTP site, the option module firmware is upgraded.

Visit the company website at www.schneider-electric.com and search for your meter type to see the available firmware and templates.

See the online ION Setup help for instructions on how to load meter templates.

Laptop computer upgrade considerations

The connection between the laptop and the device must be maintained in order for the upgrade to proceed.

Laptop computers generally have different default power properties than desktop computers.

If the laptop's hard disk shuts down or the laptop enters system standby mode, this connection is broken and the upgrade procedure must be restarted.

If you are upgrading your meter's firmware using a laptop computer, follow these guidelines:

- Plug the laptop computer into a wall outlet. Do not run the laptop on its battery.
- Configure the laptop's hard disks so that they do not shut down after a certain period of time (for example, set to "never").
- Turn off the laptop's power suspension (for example, system stand-by) and hibernate options.
- Disable the laptop's option to power down when it is closed. This prevents a shut down if the laptop is accidentally closed.
- Disable the laptop's screen saver as they can burden the CPU.

Firmware upgrade considerations

Ensure that the firmware version you are upgrading to is compatible with your meter, and that the version number is greater than your existing firmware (or else you will downgrade your meter).

Your meter's existing template may not work with different firmware versions if significant meter features have been added or modified.

Remote display (RMD) upgrade behavior

Your meter's remote display will upgrade as soon as the upgrade file is put in the remote display upgrade folder on your meter's internal FTP site. It is deleted as part of the upgrade process.

NOTE: If your meter's remote display loses power during firmware upload, the display will revert to its original firmware and you will have to reload the firmware file.

The results of your remote display firmware upgrade are stored in your meter's event log. Detailed information about your remote display, such as serial number and firmware version is provided in the Factory module.

See the *ION Reference*, available from www.schneider-electric.com, for more information about the Factory module.

Option module(s) upgrade behavior

To upgrade option modules, you must load the upgrade file into the appropriate folder on the meter's internal FTP site. The upgrade is triggered by either a power cycle or option module reset. After the upgrade is performed, the upgrade file is deleted from the meter's internal FTP site before the option module is reset to run the new firmware. The option module firmware will not upgrade if more than one upgrade file is in the folder. The upgrade file must be the correct file type and match the type of module being upgraded.

All option modules do not perform their regular functions during firmware upgrade. If more than one option module is being upgraded, the firmware on the option module closest to the meter is done first, then the next closest, proceeding to the furthest module from the meter base requiring upgrading. A single option module firmware upgrade should not take more than five minutes.

The option module upgrade results are stored in your meter's event log. Detailed information about the option module, such as serial number and firmware version is provided in the Factory module. Information about the option module type and details of the option module's state is provided in the Diagnostics module.

See the *ION Reference*, available from www.schneider-electric.com, for more information about the Factory and Diagnostic modules.

Loading meter firmware using ION Setup

You can load firmware onto your meter using ION Setup.

You can download firmware for your meter from www.schneider-electric.com.

You must load a meter template as part of the firmware upgrade process. You can save your meter's existing template by navigating to **Template > Save to PC** in the ION Setup Assistant and clicking **Save** to save your meter's template as a .DCF file. You can also use a template that you have saved from another meter of the same type, or download a factory template from www.schneider-electric.com.

Ensure that you record your meter's user and password information in a secure location before upgrading the meter's firmware. If your meter's user and password information is lost, you must return the meter for factory reconfiguration, which resets your meter to its factory defaults and destroys all logged data.

Your meter's digital and analog outputs may change state during a firmware upgrade.

▲ WARNING

UNINTENDED OPERATION

Do not use this device for critical control or protection applications where human or equipment safety relies on the operation of the control circuit.

Failure to follow these instructions can result in death, serious injury, or equipment damage.

Loading firmware or template onto your meter clears the meter's recorded data.

NOTICE

DATA LOSS

Ensure that all important data has been recorded before uploading firmware or a template to your device.

Failure to follow these instructions can result in data loss.

1. Obtain the meter firmware (.UPG) and framework (.DCF) that you want to load onto your meter. Save the files where they can be accessed by the computer running ION Setup.
2. Start ION Setup.
3. Open the Setup Assistant for your meter.
4. Select the **Template** screen.
5. Click the **Firmware Upgrade** tab, then click **Upgrade**. Enter your meter's password (if prompted) and click **OK**.
6. Navigate to the meter firmware (.UPG) file and click **Open**. Enter your ION Setup password when prompted and click **OK**.
7. Navigate to the meter framework (.DCF) file and click **OK**. The Template Paste Options dialog box appears.
8. Select the check boxes for the settings you want to retain (not overwrite) and click **OK**.

A dialog box describes the template upload and firmware upgrade progress, verifies the firmware, and finishes with an overview stating whether the firmware and framework were successfully uploaded onto your meter.

Loading option module firmware using ION Setup

You can upload firmware to your meter's option modules using ION Setup over an Ethernet connection.

You can only upload firmware to the same type of module; if you have different types of option modules connected to your meter, you must perform the upload process for each module type.

You must have:

- Your meter's option module firmware upgrade (.SI9) file. You can download upgrade files from www.schneider-electric.com.
- The option module connected to your meter, and have access to your meter's internal FTP site.
- FTP access to your meter from the computer running ION Setup.

All option modules do not perform their regular functions during firmware upgrade; they will not communicate to the meter and the outputs may change state during the upgrade process.

▲ WARNING

UNINTENDED OPERATION

Do not use this device for critical control or protection applications where human or equipment safety relies on the operation of the control circuit.

Failure to follow these instructions can result in death, serious injury, or equipment damage.

1. Obtain the option module firmware (.SI9) files that you want to load onto your option module(s). Save the files where they can be accessed by the computer running ION Setup.

2. Start ION Setup.
3. Open the Setup Assistant for your meter.
4. Select the **Template** screen.
5. Click the **Firmware Upgrade** tab, then click **Upgrade**. Enter your meter's password (if prompted) and click **OK**.
6. Navigate to where you have stored the option module firmware. Select the Option Module firmware file (*.SI9) as the file type.
7. Select the option module firmware (.SI9) file and click **Open**.
8. Enter your ION Setup password when prompted and click **OK**.

A dialog box describes the firmware upgrade progress, verifies the firmware, and finishes with an overview stating whether the firmware was successfully uploaded.

Loading remote display firmware using ION Setup

This procedure is specific to the DIN meters with a remote display, and cannot be performed on meters with an integrated display.

You can load updates to your meter's remote display firmware using ION Setup over an Ethernet connection.

You must have:

- Your meter's remote display firmware update (.BIN) file. You can download update files from www.schneider-electric.com.
- The remote display connected to your meter.
- FTP access to your meter from the computer running ION Setup.

NOTE: If your meter's remote display loses power during firmware upload, the display will revert to its original firmware and you will have to reload the firmware file.

1. Obtain the remote display firmware (.BIN) that you want to load onto your display. Save the files where they can be accessed by the computer running ION Setup.
2. Start ION Setup.
3. Open the Setup Assistant for your meter.
4. Select the Template screen.
5. Click the **Firmware Upgrade** tab, then click **Upgrade**. Enter your meter's password (if prompted) and click **OK**.
6. Navigate to where you have stored the remote display firmware. Select the remote display firmware file (*.BIN) as the file type.
7. Select the remote display firmware (.BIN) file and click **Open**.
8. Enter your ION Setup password when prompted and click **OK**.

A dialog box describes the firmware upgrade progress, verifies the firmware, and finishes with an overview stating whether the firmware was successfully uploaded.

Loading option module firmware using FTP

You can upload firmware to your meter's option modules by loading the firmware upgrade file onto your meter's internal FTP site.

You must have:

- Your meter's option module firmware upgrade (.SI9) file(s). You can download upgrade files from www.schneider-electric.com.
- The option module connected to your meter, and have access to your meter's internal FTP site.

Your meter's digital and analog outputs may change state during a firmware upgrade. Option modules are offline during an option module firmware upgrade; they will not communicate to the meter and the outputs may change state during the upgrade process.

⚠ WARNING

UNINTENDED OPERATION

Do not use this device for critical control or protection applications where human or equipment safety relies on the operation of the control circuit.

Failure to follow these instructions can result in death, serious injury, or equipment damage.

NOTE: If your meter's option module loses power during firmware upload, the option module will revert to its original firmware and you will have to reload the firmware file.

1. Connect to your meter's internal FTP site. Open the remote display upgrade (rmdUpg) folder.
2. Drag the remote display firmware file into the remote display upgrade folder. The file is immediately transferred to the remote display, and is not stored on the meter.
3. Watch your meter's display to confirm the firmware upgrade is taking place.
4. Review the remote display firmware upgrade details stored in the meter's event log to confirm that the upload was successful.

Loading remote display firmware using FTP

You can upload firmware to your meter's remote display by loading the firmware upgrade file onto your meter's internal FTP site.

You must have:

- Your meter's remote display firmware upgrade (.BIN) file. You can download upgrade files from www.schneider-electric.com.
- The remote display connected to your meter, and have access to your meter's internal FTP site.

1. Connect to your meter's internal FTP site.
2. Open the remote display upgrade (rmdUpg) folder.
3. Drag the remote display firmware file into the remote display upgrade folder. The file is immediately transferred to the remote display, and is not stored on the meter.
4. Watch your meter's display to confirm the firmware upgrade is taking place.
5. Review the remote display firmware upgrade details stored in the meter's event log to confirm that the upload was successful.

Related Topics

- Accessing your meter's FTP server
- Remote display troubleshooting icons
- Event log overview

Test mode

Test mode is typically used for verifying meter functions.

The meter is usually reading data from a test power supply while function verification is performed.

The values shown in the test mode display screens represent different accumulators than those shown in norm or alt mode (although they perform some of the same basic measurements). The test mode display values are for accuracy checking purposes; they only accumulate while the meter is in test mode.

You can create custom test mode screens and modify the existing test mode screens.

NOTE: You cannot place revenue-locked meters into test mode.

Several things to note about test mode:

- All of the billing quantities that are recorded when the meter is in Normal mode stop accumulating when the meter is switched to test mode – the data is sent to special test mode registers instead.
- The values accumulated in these test registers are displayed on the test mode displays and in ION Setup.
- The regular normal mode billing registers are unaffected while the meter is in test mode; accumulation of this data continues as soon as you exit test mode.
- All test registers are reset to zero when you exit test mode.

Test mode default screens

Your meter has default test mode display screens.

NOTE: You can modify the test mode display screens or add custom screens using ION Setup.

Screen	Description
Demand test	This screen shows test mode kW delivered and received values. Both quantities are produced from a sliding window (rolling block) demand calculation.
Reactive energy test	This screen shows test mode kVARh delivered and received values.
Active energy test	This screen shows test mode kWh delivered and received values.

Placing your meter in test mode using the display

You can put your meter into test mode using the display.

NOTE: You cannot place a revenue-locked meter into test mode.

1. Navigate to the display modes selection screen and select **Test Mode**. The test mode menu is shown before the meter goes to the first test mode screen.
2. View the test mode screens by pressing the up or down buttons.
To exit test mode, press the home button to view the test mode menu, and select **Exit Test Mode** to go to the display modes selection screen.

Placing your meter in test mode using ION Setup

You can put your meter into test mode using the ION Setup.

NOTE: You cannot place a revenue-locked meter into test mode.

1. Start ION Setup.
2. Open the Setup Assistant for your meter.
3. Navigate to **Verification** and select the **Verification** tab.
4. Select **Test Mode** and click **Display**.
Your meter is now in test mode, and the **Test Mode** screen is displayed.

5. Select the different tabs to view your meter’s test mode values and modify test mode parameters.
6. Click **Close** to take your meter out of test mode.

Test mode data and parameters available through ION Setup

Tab	Data	Parameters
Energy	<ul style="list-style-type: none"> • kWh, kVARh, kVAh delivered and received • Loss compensation status 	<ul style="list-style-type: none"> • Force TLC (transformer loss compensation) • Scaling • Test Reset
Rolling Demand	<ul style="list-style-type: none"> • kW and kW peak demand • Test demand settings 	<ul style="list-style-type: none"> • Peak Reset • Test Reset
Volts, Amps and Power	<ul style="list-style-type: none"> • kW, kVAR • Harmonics • Average, total values • Power factor, frequency 	<ul style="list-style-type: none"> • Force TLC (transformer loss compensation) • Loss Mode • Test Reset

Troubleshooting

Technical assistance

Visit www.schneider-electric.com for support and assistance with lost passwords or other technical problems with the meter.

Make sure you include your meter’s model, serial number and firmware version in your email or have it readily available if calling Technical Support.

Option module troubleshooting

Your meter’s option modules operate sequentially; if one module is non-functional all downstream modules may be affected.

If your meter cannot communicate with an option module, by default it cycles power to that module and all downstream modules, making multiple attempts to communicate. After the maximum number of communication attempts has been exceeded the meter will remove power to that module and all downstream modules.

When troubleshooting option modules, attach each option module directly to the meter and verify its operation. If each option module operates when directly connected, use combinations of modules or known good modules to help identify the issue.

Events related to option module initialization and operation are stored in your meter’s onboard event log. Perform an option bus reset to restart the option bus and re-initialize the option modules attached to your meter.

Information about your option module’s type, serial number, firmware version and present status is available in the Factory and Diagnostics modules.

See the ION Reference, available from www.schneider-electric.com, for more information about the Factory and Diagnostics modules.

Meter webpages

Webpage interface

Your meter comes with default webpages that contain typical elements.

	Minimum	Present	Maximum
Load Current			
I a (A)	3.74	3.75	3.76
I b (A)	4.99	5.00	5.01
I c (A)	4.24	4.24	4.26
I 4 (A)	0.20	0.20	0.20
I 5 (A)	0.10	0.10	0.10
I Average (A)	4.33	4.33	4.34

A	Meter type and model, device name
B	Username
C	Main menu
D	Webpage menu
E	Webpage content

NOTE: This graphic is representative only, and your meter’s webpages may appear differently than shown.

Default meter webpages

Default webpages are available on your meter.

Main menu	Webpage menu	Webpage content
Monitoring	Instantaneous Readings	<ul style="list-style-type: none"> Basic readings Energy readings Demand readings Voltage readings Power Quality
	Trending & Forecasting	Select the target and interval for trending and forecasting and view the results.
	Power Quality Summary	<ul style="list-style-type: none"> Harmonics ITI (CBEMA)-SEMI NEMA Motor Derating Curve EN50160
	Inputs/Outputs	<ul style="list-style-type: none"> Digital inputs Digital outputs Analog inputs Analog outputs
Control	Resets	Perform resets, and view when previous resets were performed.
Diagnostics	Statistics	<ul style="list-style-type: none"> Communications Ethernet Serial port

Main menu	Webpage menu	Webpage content
		<ul style="list-style-type: none"> Meter - Basic Meter - Advanced
	Phasor diagram	View the phasor diagram and numeric values.
Setup	Ethernet	<ul style="list-style-type: none"> Basic Settings Advanced settings
	Serial Port	<ul style="list-style-type: none"> Basic Settings Advanced settings
	SNMP Parameters	Configure your meter's SNMP parameters.
	NTP	Configure your meter's NTP parameters.
	SMTP	Configure your meter's SMTP parameters.
	Date & Time	Configure your meter's time and time synchronization.
	Preferences	Enter your meter's nameplate information.
	Metering	Configure the parameters that impact metered data.
Maintenance ¹	—	Custom. No default content.

¹By default the Maintenance menu is empty, and the menu is not displayed until information is added to it.

Accessing the meter's webpages for data viewing and meter configuration

You can access the meter's webpages through the meter's Ethernet connection using a web browser.

You must have cookies enabled in order to access your meter's webpages.

You may need to configure your meter's security settings in order to view webpages and configure your meter using webpages.

If you configure communications so that you can no longer communicate to and configure your meter, you must return the meter to the factory, where your meter is reset to its factory defaults and all logged data is lost.

<p>NOTICE</p> <p>DATA LOSS</p> <p>Ensure you maintain sufficient access to communicate to and configure your device.</p> <p>Failure to follow these instructions may result in data loss.</p>
--

1. Open a web browser and enter your meter's IP address in the address box.
The webpage login prompt is displayed.

2. Enter a valid username and password.

NOTE: The username and password are defined by your meter's security configuration; if standard security is enabled, the password is the same as the display password with a default username of 7400. The default display password is 0 (zero). To help increase the security of your meter's configuration and data, configure your meter's username and passwords to be different from the default values.

3. Select your desired **Language** from the dropdown list, and click **Log In**.

Your meter's webpages are displayed. The default page is the **Monitoring** webpage, showing real-time data.

4. Select the main menu tab that corresponds to the category of information you want to view, and select the webpage menu from the list on the left.

The webpage content is displayed.

5. Click the webpage content headings to expand and view the meter's data.
6. Select **Setup** to view and edit your meter's configuration.

Related Topics

- Trending and forecasting overview
- Security overview

Viewing files using your meter's webpages

You can load files of a variety of standard formats, such as *.pdf, *.jpg and *.png into the webpage folders on your meter's internal FTP site where they can be viewed using your meter's webpages.

Videos in *.mp4 format can be played in most browsers. The filenames must be compatible with your meter's FTP filename requirements.

NOTE: Image files are shown at full-size (100%). Scale images to the desired size before loading them onto your meter's internal FTP site.

1. Access your meter's internal FTP site.
2. Open the web folder. Copy your file into the subfolder that corresponds to the webpage main menu tab you want to access your file from.
3. Connect to your meter's webpages. Select the main menu item that corresponds to the folder where you stored your file in step 2. Your file is listed in the webpage menu.
4. Select your file from the webpage menu to view.

Example

To view a schematic diagram (online.pdf) of your power system from the Monitoring menu of your meter's webpages:

1. Access your meter's internal FTP site.
2. Copy online.pdf into **web > monitoring**.
3. Access your meter's internal webpages and select the **Monitoring** menu.
4. In the webpage menu click online.pdf to view your power system schematic.

Related Topics

- FTP filename requirements
- FTP

Creating custom webpages for your meter

You can create custom webpages to view data or access configuration parameters from your meter.

Download the your meter's Modbus registers map from www.schneider-electric.com.

1. Connect to your meter's internal FTP site.
2. Go to **web > examples**. Select `sample readings.html` to create a data value webpage, or select `sample configuration.html` to create a configuration parameters webpage.

3. Save a copy of the sample file. This filename is the webpage name.
4. Open your webpage in an HTML or webpage editor program.
5. Modify the webpage to reference the desired meter data or parameters from the Modbus registers map, and update the other fields where required.
6. Save your custom webpage.
The meter will display translated content if it exists in the meter’s memory. If translated content is not available, English is displayed.
7. Connect to your meter’s internal FTP site.
 - If you have created a data viewing webpage, copy your custom webpage to **web > monitoring**.
 - If you have created a configuration webpage, copy your custom webpage to **web > setup**.
8. Login to your meter’s webpages.

Your custom webpage is available from the webpage menu under the monitoring (data viewing) or setup (configuration) tab.

Related Topics

- FTP

Sample data viewing webpage

You can create custom data viewing webpages using the sample webpage stored on your meter.

The sample webpages are stored in the documents folder on your meter’s internal FTP site.

Your meter’s Modbus register map is available from www.schneider-electric.com.

If required, your meter’s ION handles document is packaged with the meter firmware file which is available for download from www.schneider-electric.com.

The data viewing webpage must be stored on your meter’s internal FTP site in the folder for Monitoring. The custom webpage is viewed by selecting the Monitoring main menu tab on your meter’s webpage.

Configuring the HTML code other than where described is an advanced procedure and should only be performed by those with an advanced understanding of webpages and how your meter processes them.

Sample webpage data viewing result

NOTE: This graphic is representative only, and your meter’s webpages may appear different than shown.

Basic Readings			
	Minimum	Present	Maximum
I a (A)	0.00	3.76	3.76
I b (A)	0.00	5.01	5.01

A	HTML filename
B	Content pane title
C	Row heading
D	Units
E	Column heading

F	Named register instantaneous value
G	Second content pane A title

Sample HTML code for data viewing webpage content

Content and formatting of a data viewing webpage is controlled by its HTML code.

Sample data viewing webpage content

Line #	Sample HTML
1	SampleMonitorPane.html
2	<div class="content-fit">
3	<div class="accordion">
4	<h3 target="sample-readings">\${%localizedString(Basic Readings) #}\$</h3>
5	<div id="sample-readings">
6	<table class="datatable">
7	<tr>
8	<th> </th>
9	<th>\${%localizedString(Minimum) #}\$</th>
10	<th>\${%localizedString(Present) #}\$</th>
11	<th>\${%localizedString(Maximum) #}\$</th>
12	</tr>
13	<tr class="minor">
14	<td>\${%localizedString(I a) #}\$ </td>
15	<td regname="I a mn"></td>
16	<td regname="I a"></td>
17	<td regname="I a mx"></td>
18	</tr>
19	<tr class="minor">
20	<td>\${%localizedString(I b) #}\$ </td>
21	<td regname="I b mn"></td>
22	<td regname="I b"></td>
23	<td regname="I b mx"></td>
24	</tr>
25	</table>
26	</div>
27	<h3 target="sample-energy">\${%localizedString(Energy Readings) #}\$</h3>
28	<div id="sample-energy">
29	<table class="datatable">
30	<tr>
31	<th> </th>
32	<th>\${%localizedString(Present) #}\$</th>
33	</tr>
34	<tr>
35	<td>\${%localizedString(Active Energy) #}\$ </td>
36	<td regname="kWh del-rec"></td>
37	</tr>

Sample data viewing webpage content

Line #	Sample HTML
38	<tr>
39	<td>\${%localizedString (Reactive Energy) # \$ </td>
40	<td regname="kVARh del-rec"></td>
41	</tr>
42	</table>
43	</div>
44	</div>
45	
46	
47	<script type="text/javascript">
48	
49	instantaneousReadings.initInstantaneousReadings ('sample-readings');
50	
51	</script>
52	</div>

Sample webpage data viewing content description

Line #	Description
1	SampleMonitorPane.html The HTML filename, including the HTML extension (.html). This filename must comply with FTP filename conventions (no spaces or special characters). The filename (without the HTML extension) is the name shown on the webpage menu.
4	<h3 target="sample-readings"> This creates the first webpage content pane. "sample-readings" is the name of the webpage content. This name must be unique. \${%localizedString (Basic Readings) # \$</h3> Basic Readings is the title of the webpage content pane. This title is translated if possible.
5	<div id="sample-readings"> This must match the name of the webpage content in line 4.
9	<th>\${%localizedString (Minimum) # \$</th> Minimum is the heading for the first column. This heading is translated if possible.
10	<th>\${%localizedString (Present) # \$</th> Present is the heading for the second column. This heading is translated if possible.
11	<th>\${%localizedString (Maximum) # \$</th> Maximum is the heading for the last column. This heading is translated if possible.
14	<td>\${%localizedString (I a) # \$ I a is the row heading. This heading is translated if possible. </td> This displays the units that the meter has defined for the named register I a.
15	<td regname="I a mn"></td> This displays the instantaneous value of the named register I a mn.
16	<td regname="I a"></td> This displays the instantaneous value of the named register I a.
17	<td regname="I a mx"></td> This displays the instantaneous value of the named register I a mx.
20	<td>\${%localizedString (I b) # \$ I b is the second row heading. This heading is translated if possible. </td> This displays the units that the meter has defined for the named register I b.
21	<td regname="I b mn"></td> This displays the instantaneous value of the named register I b mn.
22	<td regname="I b"></td> This displays the instantaneous value of the named register I b.

Sample webpage data viewing content description

Line #	Description
23	<code><td regname="I b mx"></td></code> This displays the instantaneous value of the named register I bmx.
27	<code><h3 target="sample-energy"></code> This creates the second webpage content pane. Sample-energy is the name of the webpage content. This name must be unique. <code>`\${localizedString(Energy Readings)}\$`</h3></code> Energy Readings is the title of the webpage content pane. This title is translated if possible.
28	<code><div id="sample-energy"></code> This must match the name of the webpage content in line 27.
32	<code><th>`\${localizedString(Present)}\$`</th></code> Present is the heading for the last column. This heading is translated if possible.
35	<code><td>`\${localizedString(Active Energy)}\$`</code> Active Energy is the row heading. This heading is translated if possible. <code></td></code> This displays the units that the meter has defined for the named register kWh del-rec.
36	<code><td regname="kWh del-rec"></td></code> This displays the instantaneous value of the named register kWh del-rec. ¹
39	<code><td>`\${localizedString(Reactive Energy)}\$`</code> Reactive Energy is the row heading. This heading is translated if possible. <code></td></code> This displays the units that the meter has defined for the named register kVARh del-rec.
40	<code><td regname="kVARh del-rec"></td></code> This displays the instantaneous value of the named register kVARh del-rec. ¹
49	<code>instantaneousReadings.initInstantaneousReadings('sample-readings');</code> Sample-readings is the unique name of the first webpage content name. This HTML code updates all of the webpage's values.

¹Named registers are listed in the Modbus registers map. If the desired value is not listed, you can reference the value by its ION handle, using the following format: `<td regname="_0x####"></td>`, where `####` is the hexadecimal value of the ION handle.

Sample setup webpage

You can create custom setup webpages using the sample webpage stored on your meter.

Sample webpages are stored in the documents folder on your meter's internal FTP site.

Your meter's Modbus register map is available from Schneider Electric.

If required, your meter's ION handles document is packaged with the meter firmware file which is available for download from www.schneider-electric.com.

Custom setup webpages must be stored on your meter's internal FTP site in the folder for Setup. The custom webpage is viewed by selecting the Setup main menu tab on your meter's webpage.

Configuring the HTML code other than where described is an advanced procedure and should only be performed by those with an advanced understanding of webpages and how your meter processes them.

Sample webpage setup result

NOTE: This graphic is representative only, and your meter's webpages may appear different than shown.

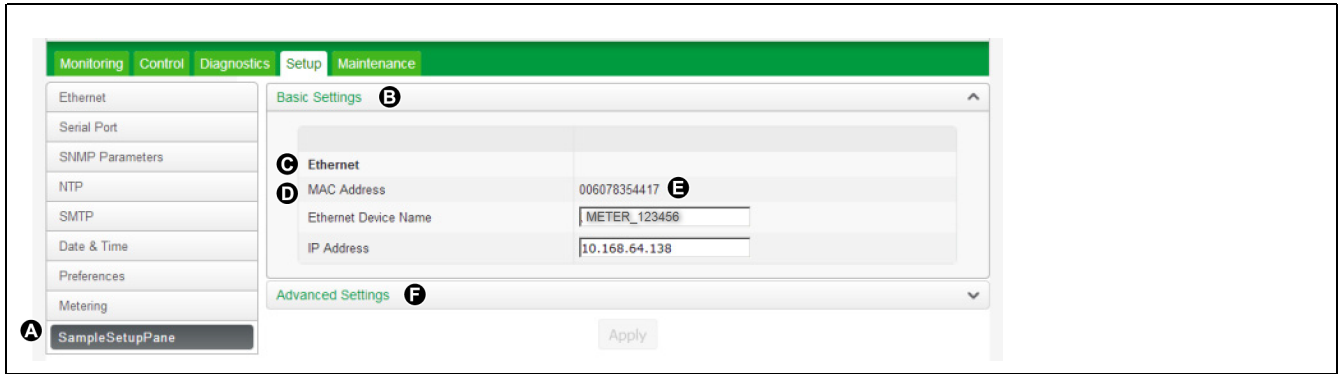

A	HTML filename
B	Content pane title
C	Sub-heading
D	Row heading
E	Named register value
F	Second content pane title

Sample HTML code for setup webpage content

Content and formatting of a setup webpage is controlled by its HTML code.

Sample setup webpage content

Line #	Sample HTML
1	SampleSetupPane.html
2	
3	<div class="content-fit">
4	<form id="formSampleSettings">
5	
6	<div class="accordion">
7	<h3 target="sample-basic">\${localizedString(Basic Settings)} #</h3>
8	<div id="sample-basic">
9	<table class="formtable">
10	<tr>
11	<th> </th>
12	<th> </th>
13	</tr>
14	<tr>
15	<td>\${localizedString(Ethernet)} #</td>
16	<td> </td>
17	</tr>
18	<tr class="minor">
19	<td>\${localizedString(MAC Address)} #</td>
20	<td regname="MAC Address"></td>
21	</tr>
22	<tr class="minor">
23	<td>\${localizedString(Ethernet Device Name)} #</td>
24	<td><input name="Ethernet Device Name" type="text" /></td>
25	</tr>

Sample setup webpage content

Line #	Sample HTML
26	<tr class="minor">
27	<td>\${%localizedString (IP Address) #}\$</td>
28	<td><input name="IP Address" type="text" /></td>
29	</tr>
30	</table>
31	
32	</div>
33	
34	<h3 target="sample-advanced">\${%localizedString (Advanced Settings) #}\$</h3>
35	<div id="sample-advanced">
36	<table class="formtable" id="frameFormatDropdownContainer">
37	<tr>
38	<th> </th>
39	<th> </th>
40	</tr>
41	<tr>
42	<td>\${%localizedString (TCP Keep Alive Minutes) #}\$</td>
43	<td><input type="text" name="TCP Keep Alive Minutes" class="small" /> </td>
44	</tr>
45	<tr>
46	<td>\${%localizedString (Enable Web Server) #}\$</td>
47	<td><select name="Enable Web Server"></select> </td>
48	</tr>
49	</table>
50	
51	</div>
52	</div>
53	
54	<input type="submit" class="apply" value='\${%localizedString (Apply) #}\$' />
55	
56	</form>
57	
58	
59	<script type="text/javascript">
60	
61	SetupPane.init('formSampleSettings');
62	formChangeDetection.initFormChangeDetection('#formSampleSettings', '#dialogFormChanges');
63	
64	</script>
65	</div>

Sample setup webpage content description

Line #	Description
1	SampleSetupPane.html The HTML filename, including the HTML extension (.html). This filename must comply with FTP filename conventions (no spaces or special characters). The filename (without the HTML extension) is the name shown on the webpage menu.
4	<form id="formSampleSettings"> "formSampleSettings" is the name of the webpage content. This name must be unique
7	<h3 target="sample-basic"> This creates the first webpage content pane. "sample-basic" is the name of the webpage content. This name must be unique. \$%localizedString(Basic Settings) #\$/h3> Basic Settings is the title of the webpage content pane. This title is translated if possible.
8	<div id="sample-basic"> This must match the name of the webpage content in line 7.
15	<td>\$%localizedString(Ethernet) #\$/td> Ethernet is the subheading. This heading is translated if possible.
19	<td>\$%localizedString(MAC Address) #\$/td> MAC Address is the row heading. This heading is translated if possible.
20	<td regname="MAC Address"></td> This displays the value of the read-only named register MAC Address.
23	<td>\$%localizedString(Ethernet Device Name) #\$/td> Ethernet Device Name is the row heading. This heading is translated if possible.
24	<td><input name="Ethernet Device Name" type="text" /></td> This displays the instantaneous value of the configurable named register Ethernet Device Name in a text-edit field. The type must match the named register type, in this case, an alphanumeric string.
27	<td>\$%localizedString(IP Address) #\$/td> IP Address is the row heading. This heading is translated if possible.
28	<td><input name="IP Address" type="text" /></td> This displays the instantaneous value of the configurable named register IP Address in a text-edit field. The type must match the named register type, in this case, an alphanumeric string.
34	<h3 target="sample-advanced"> This creates the second webpage content pane. Sample-advanced is the name of the webpage content. This name must be unique. \$%localizedString(Advanced Settings) #\$/h3> Advanced Settings is the title of the webpage content pane. This title is translated if possible.
35	<div id="sample-advanced"> This must match the name of the webpage content in line 34.
42	<td>\$%localizedString(TCP Keep Alive Minutes) #\$/td> TCP Keep Alive Minutes is the row heading. This heading is translated if possible.
43	<td><input type="text" name="TCP Keep Alive Minutes" class="small" /> This displays the instantaneous value of the configurable named register TCP Keep Alive Minutes in a text-edit field. The type must match the named register type, in this case, an alphanumeric string. </td> This displays the units that the meter has defined for the named register TCP Keep Alive Minutes. NOTE: There are no defined units for TCP Keep Alive Minutes, so no units are displayed.
46	<td>\$%localizedString(Enable Web Server) #\$/td> Enable Web Server is the row heading. This heading is translated if possible.
47	<td><select name="Enable Web Server"></select></td> Enable Web Server is the named register that is displayed. Named registers are listed in the meter's registers map. The type must match the named register type, in this case, an enumerated value that is displayed as a drop-down list.

Sample setup webpage content description

Line #	Description
61	<code>SetupPane.init('formSampleSettings');</code> This must match the webpage content name from line 4.
62	<code>formChangeDetection.initFormChangeDetection('#formSampleSettings', '#dialogFormChanges');</code> This must match the webpage content name from line 4. This HTML code updates all of the webpage's values.

Logging

Logging overview

The meter is equipped with data recorders that enable you to log and monitor various metering functions and features.

Your meter can support up to 50 logs (data recorders) which can each record up to 16 different parameters.

Your meter has a number of onboard default logs (also called data recorders) that are used to store data related to:

- Power quality and compliance
- Trending and forecasting
- Energy/revenue metering
- Meter events

Your meter also logs voltage and current waveform data when a sag or swell is detected. You must enter your power system's nominal values and configure your meter so that it can identify sags and swells. You can configure your meter's setpoint learning feature to learn your power system's normal operating values and use that information to help identify voltage sags and swells.

Logged data can be retrieved by energy management software.

Related Topics

- Minimum configuration requirements for basic metering

Default logging capacity

Your meter's preconfigured data and waveform recorders have default logging depths and intervals.

Data recorder number	Log name	Depth	Interval
1	Revenue Log	3360 (35 days)	900 seconds (15 minutes)
9	Loss Log	3360 (35 days)	900 seconds (15 minutes)
2, 3, 4	Historic Logs	3360 (35 days)	900 seconds (15 minutes)
39	Daily Nominal Log	450	Triggered on demand
7, 8	Harmonics Logs	840 (35 days)	3600 seconds (1 hour)
N/A	Waveform recorders (6 total)	30	Triggered on demand
N/A	COMTRADE records	1	Triggered by waveform recording
10	Energy/demand (EgyDmd Log)	3360 (35 days)	900 seconds (15 minutes)
5	Sag/swell Log	100	Triggered on demand
N/A	Event Log	500	Triggered on demand
11 - 14, 17, 19 - 26, 28, 29, 32, 35	EN50160 Logs	varies	EN50160 intervals
6, 16, 37, 38, 40	4-30 Logs	varies	IEC61000-4-30 intervals

Log depth configuration

You can change the number of records (depth) stored in the log.

Use ION Setup to change the number of records (depth) stored in the log. Changing how the log records information (circular, or stop-when-full) is an

advanced procedure to change the RecordMode setup register in the Data Recorder and Waveform Recorder modules.

Data logs and circular format waveform recorders have a minimum depth of 2 records.

Log interval configuration

You can change the logging intervals for the revenue and energy demand log.

Use ION Setup to change the logging intervals for the revenue and energy demand log.

Changing the interval for other data logs is an advanced procedure to modify the Periodic Timer module's Period setup register, which triggers the data log's recording.

Do not change the Periodic Timer module's Sync Mode setup register.

The default Periodic Timer modules that control the frequency of different data recording are as follows:

- Revenue Log Trg: controls the frequency of the logging of revenue values
- Loss Log Trg: controls the frequency of Loss Compensation Data logging
- EgyDmd Log Trg: controls the frequency of logging for the Energy and Demand Log (this log is used by Power Monitoring Expert software to generate reports.
- Hist Log Trg: controls the frequency of Historic Data logging
- Harm Log Trg: controls the frequency of Harmonics logging

Programming your meter to write to any data recorder at continuous intervals shorter than 60 seconds (heavy logging configuration) can cause loss of data in the event of a power failure.

NOTICE

DATA LOSS

Use an uninterruptible power supply (UPS) if you program your meter for heavy logging.

Failure to follow these instructions can result in data loss.

Data log memory calculations

The amount of memory required to store data and event logs depends on the number of parameters being logged and the frequency with which these parameters are logged.

The memory required is calculated as follows:

Memory consumption for each record (in Bytes) = [(number of parameters x 5) + 8]

For example, a data log recording three parameters consumes 23 Bytes of data. If the data is recorded every 15 minutes for 35 days, the data log requires approximately 80 kiloBytes of logging memory.

Waveform record memory calculations

The meter can simultaneously capture waveforms triggered by events on all channels to a maximum of 96 cycles for each waveform record.

The memory required is calculated as follows:

Memory consumption for each waveform (in Bytes) = [2 x number of samples per cycle + 12] x [number of cycles in waveform x 2] + 32.

A single waveform record requires approximately 8 kB of memory.

See the ION Setup online help, available from www.schneider-electric.com, for more information about the logging memory allocations and other meter logging memory information displayed by the ION Setup Assistant.

Data logging overview

Your meter has data logging capabilities, including a special type of data log which is an event log, which logs prioritized events.

Data logs are recorded by your meter and stored in the meter’s memory inside configurable data logs. Your meter’s data logs are retained if the meter loses power.

Logged data can be used by energy management software. Logs can be configured to either overwrite the oldest data when full (circular), or to stop writing data to the log when the number of logged records reaches the maximum log depth (stop-when-full).

Your meter ships with a comprehensive data-logging configuration consisting of data logs set up to record values at specific intervals or on conditions. Your meter’s default data logging configuration should be sufficient for most applications, but you can also reconfigure existing logs or create new logs for custom applications if needed.

Your meter can also be configured to email data log information.

NOTE: Adding or deleting data logs or their parameters outside of the ION Setup Assistant should only be undertaken by those with an advanced understanding of ION architecture and their meter’s template.

See the *Internal email client feature* technical note, available from www.schneider-electric.com, for instructions on how to configure your meter to email logged data.

See the *ION Reference*, available from www.schneider-electric.com, for more information about ION architecture and ION modules.

Default data logging configuration

Your meter is equipped with preconfigured data logs which you can modify.

The default data logging configuration might be used by other components of your power monitoring system. Do not change the default configuration of any of the logs unless you understand the impact of the change on these power monitoring system components, the data they use and your meter’s memory.

Revenue log

The Revenue Log is configured for use with UTS MV-90 billing software. The default values logged by the Revenue Log are as follows:

Parameter	Description
kWh del int	Interval kWh delivered
kWh rec int	Interval kWh received
kVARh del int	Interval kVARh delivered
kVARh rec int	Interval kVARh received

Historic data logs

Three historic data logs are used to record standard power system quantities, such as phase current, phase voltage and power factor. These logs are labeled Hist Mean Log, Hist High Log, and Hist Low Log. By default, they log the following values:

Hist High Log	
Vll ab high	I avg high
Vll bc high	I 4 high
Vll ca high	kW tot high
Vll avg high	kVAR tot high
V unbal high	kVA tot high
Ia high	PF lag high
Ib high	PF lead high
Ic high	Freq high

Hist Mean Log	
Vll ab mean	I avg mean
Vll bc mean	I 4 mean
Vll ca mean	kW tot mean
Vll avg mean	kVAR tot mean
V unbal mean	kVA tot mean
Ia mean	PF lag mean
Ib mean	PF lead mean
Ic mean	Freq mean

Hist Low Log	
Vll ab low	I avg low
Vll bc low	I 4 low
Vll ca low	kW tot low
Vll avg low	kVAR tot low
V unbal low	kVA tot low
Ia low	PF lag low
Ib low	PF lead low
Ic low	Freq low

Loss log

The Loss Log is configured to record loss values. By default, it logs the following values:

Parameter	Description
MU Ia^2h int	Phase A interval current squared hours
MU Ib^2h int	Phase B interval current squared hours
MU Ic^2h int	Phase C interval current squared hours
MU Vllab^2h int	Phase A interval voltage Line-to-Line squared hours
MU Vllbc^2h int	Phase B interval voltage Line-to-Line squared hours
MU Vllca^2h int	Phase C interval voltage Line-to-Line squared hours

Parameter	Description
MU VIn a^2h int	Phase A interval voltage Line-to-Neutral squared hours
MU VIn b^2h int	Phase B interval voltage Line-to-Neutral squared hours
MU VIn c^2h int	Phase C interval voltage Line-to-Neutral squared hours

Harmonics logs

Two harmonics logs record various harmonics data, including K-factor and Total Harmonic Distortion (THD). These recorders are labeled Harm Mean Log and Harm High Log. By default, they log the following values:

Harm Mean Log	Harm High Log
V1 THD mean	V1 THD high
V2 THD mean	V2 THD high
V3 THD mean	V3 THD high
I1 THD mean	I1 THD high
I2 THD mean	I2 THD high
I3 THD mean	I3 THD high
I1 K Fac mean	I1 K Fac high
I2 K Fac mean	I2 K Fac high
I3 K Fac mean	I3 K Fac high

Energy/demand log

The Energy/demand log records energy and demand data used by energy management software to generate reports. Changing the logged data can prevent the generation of reports that use this data.

Sag/swell log

The Sag/swell Log provides details of power quality events. By default, it logs the following values:

SS1 DistDur	SS1 DistV1Min	SS1 DistV1Max	SS1 DistV1Avg
SS1 DistV1Engy	SS1 DistV2Min	SS1 DistV2Max	SS1 DistV2Avg
SS1 DistV2Engy	SS1 DistV3Min	SS1 DistV3Max	SS1 DistV3Avg
SS1 DistV3Engy	SS1 DistNominal	SS1 Swell Lim	SS1 Sag Lim

EN50160 compliance logs

The EN50160 compliance logs are used to record EN50160 compliance parameters:

Data recorder	EN50160 component logged
EN50160 Flicker	Flicker
EN50160 Frq/Mg	Power frequency and supply magnitude
EN50160 Hrm VIt	Harmonics
EN50160 Intrp	Short/log interruptions
EN50160 OvrVlt1	Temporary overvoltage
EN50160 OvrVlt2	Temporary overvoltage

Data recorder	EN50160 component logged
EN50160 Prm-f/V	Parameter data (disabled by default)
EN50160 Prm-Vlr	Parameter data (disabled by default)
EN50160 Vunbal	Voltage unbalance
EN50160 PrmHrm1	Parameter data (disabled by default)
EN50160 PrmHrm2	Parameter data (disabled by default)
EN50160 Vlt Dp1	Supply voltage dips
EN50160 Vlt Dp2	Supply voltage dips
EN50160 Vlt Dp3	Supply voltage dips
EN50160 Vlt Dp4	Supply voltage dips
EN50160 Vlt Dp5	Supply voltage dips

The meter logs EN50160 counter data for present and previous observation periods as well as EN51060 events.

See the EN50160 2010 compliance and ION meters technical note, available from www.schneider-electric.com, for more information about your meter's EN50160 compliance.

4-30 compliance logs

Four 4-30 compliance logs are used to log parameters related to the International Electrotechnical Commission's IEC 61000-4-30 standards' power quality compliance and to create reports:

Data recorder	4-30 parameters logged
4-30 10m Log	PqFlag V1 V2 V3 V1 THD (Total Harmonic Distortion) V2 THD V3 THD NegSeqComp (Vneg/Vpos) ZeroSeqComp (Vzero/Vpos) Power Freq
4-30 2hr Log	PqFlag V1 V2 V3 V1 THD (Total Harmonic Distortion) V2 THD V3 THD NegSeqComp (Vneg/Vpos) ZeroSeqComp (Vzero/Vpos) Power Freq
4-30 3s Log	PqFlag V1 V2 V3 V1 THD (Total Harmonic Distortion) V2 THD V3 THD NegSeqComp (Vneg/Vpos) ZeroSeqComp (Vzero/Vpos)

Data recorder	4-30 parameters logged
	Power Freq
4-30 10s Freq	Power Frequency PqFlag
4-30 V Intrp DrtnAll	Voltage interruption duration (all voltages)

See the 4-30 Compliance and ION Meters technical note, available from www.schneider-electric.com, for more information about your meter's 4-30 compliance.

Event log overview

Your meter records events produced by the meter's ION modules or external meter events.

Meter events, such as meter configuration or changes to I/O state, have priority values associated with them, so you can control what events are logged. Each event has a priority based on its type and severity, and for most events you can configure the priority. The event log records the date and time of the event, along with relevant details about the event.

Your meter's event log can be viewed through the meter's display and ION Setup.

Event log data example:

Date/Time	Cause	Value	Effect	Value
11/10/2014 11:21:13.577 AM	Ethernet	FTP	Front Panel	Auth FAIL
11/10/2014 11:21:43.000 AM	Front Panel	Remote Display	Front Panel	File received on RMD
11/10/2014 11:24:45.000 AM	Front Panel	Remote Display	Front Panel	RMD firmware upgrade successful
11/10/2014 11:24:48.135 AM	Front Panel	Remote Display	Front Panel	RMD disconnected
11/10/2014 11:25:15.820 AM	Front Panel	Remote Display	Front Panel	RMD connected
11/10/2014 11:29:27.316 AM	Ethernet	FTP	Front Panel	Auth FAIL

NOTE: This example is representative only, and your meter's event log may appear different than shown.

See the ION Reference, available from www.schneider-electric.com, for more information about the Event Log Controller module and other ION modules.

Related Topics

- Data viewing using your meter's display

Default event log configuration

Your meter logs all configuration changes, meter access events, and power system events.

You can configure certain features, such as the digital inputs, so an event is logged when the feature changes state (for example, the digital input changes from off to on).

Your meter's event log might be used by other components of your power monitoring system. Do not change the default event log configuration unless you understand the impact of the change on the power monitoring system components and the data they use and on your meter's memory.

Changing the default event log configuration should only be undertaken by those with an advanced understanding of ION architecture and their meter's template.

The event log is controlled by the Event Log Controller module, which allows you to set a priority cutoff for event logging. Events with a priority number greater than the cutoff value are logged, and events with lower priorities are discarded. By default, this value is set so that all relevant events are recorded in the meter's event log. Event priority values range from 0 to 255 with a typical cutoff value of 5.

NOTE: Alarms are generated by events from certain ION modules. The alarm level is determined by the priority of the associated event. To disable the alarm but still record the associated event, set the alarm priority to info only. To disable the alarm and the event, set the alarm priority to none.

See the ION Reference, available from www.schneider-electric.com, for more information about the Event Log Controller module and event priorities for specific ION modules.

Related Topics

- Alarms overview

Waveform recording overview

Your meter is able to record voltage and current waveform information.

Waveform information is used to help identify power system disturbances, which are an increasing concern for industrial plants, hospitals, data centers and other facilities where the equipment is sensitive to voltage or current sags, swells, and momentary interruptions. Waveform information is also used to help ensure compliance with power quality standards.

In addition to measuring and recording numerical values for voltage and current, your meter can also capture the sinusoidal waveform data. The current and voltage waveform data provides additional information for analysis of the system's power quality or a power quality event.

You can manually trigger waveform recordings or configure them to trigger automatically when there is a power quality or power system event. For waveform recording to trigger automatically, you must enter your system's nominal (normal) voltage and current values, and then the amount of deviation from the nominal required to trigger waveform recording.

Your meter's waveform data storage format is defined by:

- Cycles: the number of cycles (based on your power system's frequency) included in the waveform (its duration).
- Samples: samples per cycle, which is the number of waveform data points collected in each cycle.

This gives you the option to record a lot of information for a very short duration or less information over a longer duration. You can also configure a delay in starting waveform recording which allows you to record pre- and post-event data.

You can use your meter to detect ITI (CBEMA) - type disturbances, and can determine information regarding the magnitude and duration of each disturbance. This information can be used by your energy management system to plot the disturbance on a CBEMA curve.

COMTRADE waveform data is available from your meter.

NOTE: If you are generating COMTRADE waveform information, the associated waveform recorders cannot be modified unless COMTRADE is disabled. If the waveform recorders are not configured identically, COMTRADE waveform information will not be generated.

Key terms

Term	Definition
COMTRADE	COMMon format for TRAnsient Data Exchange (COMTRADE) is a common format for waveform data.
ITI (CBEMA)	A curve that graphically describes an AC input voltage envelope which can be typically tolerated by information technology equipment. Meter waveform information is plotted on this curve to help evaluate power quality.
Nominal	The normal or usual parameter value. For example, the nominal voltage for many power systems is 120 V.

Term	Definition
Sag	A power event where the voltage or current drops below the nominal value.
Swell	A power event where the voltage or current rises above the nominal value.

See the ION Reference, available from www.schneider-electric.com, for more information on the Waveform Recorder module and its settings.

Related Topics

- Setpoint learning overview
- COMTRADE
- Minimum configuration requirements for basic metering

Default waveform recording configuration

Your meter's waveform recording operates once your nominal values are configured.

Your meter has the following default waveform recorders:

Waveform recorder	Description
Wfm Rc V1-Sg/Sw	V1 voltage waveforms recorded during a defined sag or swell event.
Wfm Rc V2-Sg/Sw	V2 voltage waveforms recorded during a defined sag or swell event.
Wfm Rc V3-Sg/Sw	V3 voltage waveforms recorded during a defined sag or swell event.
Wfm Rc I1-Sg/Sw	I1 current waveforms recorded during a defined sag or swell event.
Wfm Rc I2-Sg/Sw	I2 current waveforms recorded during a defined sag or swell event.
Wfm Rc I3-Sg/Sw	I3 current waveforms recorded during a defined sag or swell event.

Configuring waveform recording using ION Setup

You can configure waveform recording using ION Setup.

For waveform recording to trigger automatically, you must enter your system's nominal (normal) voltage and current values, and then the amount of deviation from the nominal required to trigger waveform recording.

Changing your meter's waveform recording configuration clears your meter's existing waveform records.

NOTICE
<p>DATA LOSS</p> <p>Ensure that all important data has been recorded before configuring waveform recording.</p> <p>Failure to follow these instructions can result in equipment damage.</p>

1. Start ION Setup.
2. Open the Setup Assistant for your meter.
3. Navigate to **Alarming** and click the **Sag/Swell** tab. Configure your meter's sag/swell detection parameters.

4. Navigate to **Power Quality** and click the **Sag/Swell** tab to configure your meter's waveform recording parameters.

NOTE: COMTRADE status must be set to **Disabled** before modifying the waveform format.

Sag/swell detection parameters

Parameter	Values/Range	Description
Nominal voltage	0 - 999,999	Specifies the nominal voltage value used for sag/swell detection.
Voltage Swell %	Percentage of nominal	Specifies how much a measured value must exceed the nominal in order to be considered a swell.
Voltage Sag %	Percentage of nominal	Specifies how much a measure value must fall below the nominal in order to be considered a sag.
Nominal current	0 - 999,999	Specifies the nominal current used by Swell and Sag limit % for a current sag or a current swell.
Current Sag Pickup	Numeric value	Specifies the percentage the current must deviate from the nominal current in order to be classified as a sag.
Current Sag Dropoff	Numeric value	Specifies the additional amount that the current must recover in order to signal the end of the sag.
Current Swell Pickup	Numeric value	Specifies the percentage the current must deviate from the nominal current in order to be classified as a swell.
Current Swell Dropout	Numeric value	Specifies the additional amount that the current must recover in order to signal the end of the event.

Waveform recording parameters

Parameter	Description
Sag/Swell depth	Specifies the number of records the sag/swell data log can hold.
Waveform depth	Specifies the maximum number of waveform records stored on the meter.
Waveform format	Specifies the number of samples per cycle and the number of cycles that are stored in a waveform record.
Post event cycles	Specifies the number of cycles recorded after the waveform is triggered. NOTE: The maximum number of post event cycles cannot exceed the number of cycles in the waveform record.
Hysteresis %	Specifies the difference in magnitude between the start and end thresholds for a power quality event.

Setpoint learning overview

Your meter can learn acceptable ranges or thresholds by monitoring normal operating values to determine what constitutes a voltage sag or swell in order to help identify high and low setpoints.

NOTE: To help your meter learn the most accurate values possible, it is important that learning occur during a period of normal operation. Do not schedule learning during a period of unusual operations in your system. Do not modify your meter's configuration during the learning period as it may stop the learning process.

You can configure the meter so that learned values are applied automatically once the learning period is complete or require that they are reviewed and manually applied. If a learned value is invalid, the learned values are not automatically applied, but logged for review.

Setpoint learning can be used to identify the following values:

Feature	Values
Setpoints (Alarms)	High limit Low limit Sustain until ON Sustain until OFF
Sag	Voltage sag limit
Swell	Voltage swell limit

Learning installation mode and learning duration

You can configure learning for manual or automatic mode.

There are two learning installation modes:

- Manual: the meter learns the applicable values but does not begin using the learned values. The learned values are recorded for review, and you can decide to use the learned values or adjust them as required before manually implementing the learned values.
- Automatic: the meter learns the applicable values and begins using those learned values automatically at the end of the learning period. If a learned value is invalid, the meter does not apply the value, but the value is recorded in the event log.

You can configure the maximum learning duration. The actual learning duration may vary, depending on the stability of the system. If the system is stable for a period equal to one quarter of the maximum learning duration, learning is complete; otherwise, the learning period will be the maximum learning duration.

Example: Setpoint learning duration in a stable system

In this example, the learning duration is 30 days. When the system is stable for 7.5 days (one quarter of 30 days) learning is complete.

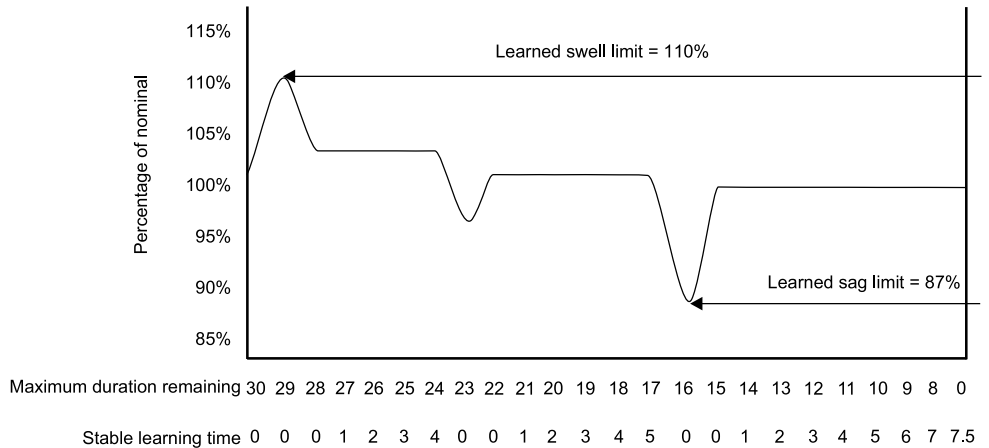

Example: Setpoint learning duration in an unstable system

In this example, the learning duration is 30 days. Because the system is not stable for 7.5 days (one quarter of the 30 days) learning is complete at the end of the maximum learning duration.

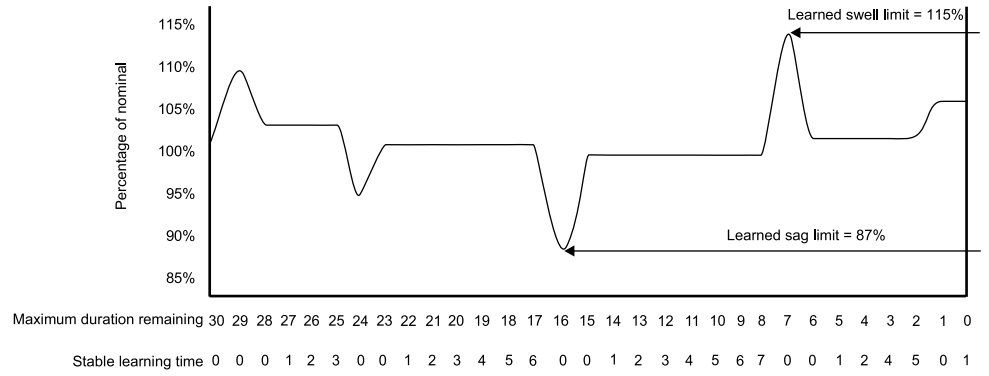

See the ION Reference, available from www.schneider-electric.com, for more information on Sag/Swell, Setpoint and Relative Setpoint modules.

Related Topics

- Implementing sag/swell limit learning using ION Setup
- Implementing alarm setpoint learning using ION Setup

Inputs / outputs

I/O Overview

Your meter has onboard digital I/O which can be increased by adding optional digital and analog I/O modules to expand your meter's I/O capabilities.

Your meter base has:

- 3 digital inputs
- 1 form A digital output
- 2 energy pulsing LEDs (one visible, one infrared)

Your meter's integrated display has:

- kWh energy pulsing LEDs (one visible, one infrared)
- kVARh energy pulsing LEDs (one visible, one infrared)
- an optical port that can be used for energy pulsing

You can view information about your meter's I/O through the display and webpages, and configure your meter's I/O using ION Setup.

Input/output ION modules

ION modules are used to configure your meter's digital or analog inputs/outputs (I/O).

You need to configure the following ION modules in order to use the meter's digital or analog I/O.

- Digital input: uses the Digital Input module, which tells the meter how to interpret incoming signals.
- Digital output: uses one of three ION modules depending on the application.
 - Digital Output module: monitors a change of state to control relay operation via a hardware output device.
 - Pulser module: transfers high-speed pulses to a hardware pulse counting device that is used to track energy usage.
 - Calibration Pulser module: integrates instantaneous power inputs, then outputs high-speed pulses to an LED that can be monitored for energy accuracy verification.

NOTE: All of these modules can act as intermediaries between the physical hardware port and the other modules in the meter. They define the characteristics of the outgoing signals.

- Analog input: uses the Analog Input module, which tells the meter how to interpret an incoming analog voltage or current signal from transducers.
- Analog output: uses the Analog Output module to deliver a continuous direct voltage or current analog signal to transducers.

Input/output ION modules, ports and labels

You can configure the Digital Output, Digital Input, Analog Input, Analog Output, Pulser and Calibration Pulser ION modules to specify which port handles the outgoing or incoming signals.

To assign a port to one of these modules, simply modify the Port setup register by picking a port from the enumerated list.

The following tables describe the ports that can be configured to handle outgoing or incoming signals.

Onboard input and output ports

ION module type	ION module name	Hardware port (device label)	Port name (ION label)	Description
Digital Output	Port D1	D1	Port D1	Form A output
Calibration Pulser	Top LED	N/A	Top LED	Watt energy pulsing (located on meter body)
	WATT LED	WATT	WATT LED	Watt energy pulsing (located on integrated display)
	VAR LED	VAR	VAR LED	VAR energy pulsing (located on integrated display)
	Optical Port	Optical port	Optical Port LED	Watt energy pulsing (located on integrated display)
Digital Input	Port S1	S1	Port S1	Externally excited
	Port S2	S2	Port S2	Externally excited
	Port S3	S3	Port S3	Externally excited

Option module(s) input and output ports

ION module type	ION module name	Hardware port (device label)	Port name (ION label)	Description
Digital Input	Port A/B/C/D-S1-S6	S1 - S6	Port A S1 - S6 Port B S1 - S6 Port C S1 - S6 Port D S1 - S6	Option module digital inputs
Digital Output	Port A/B/C/D D1 - D2	Relay 1 - Relay 2	Port A D1 - D2 Port B D1 - D2 Port C D1 - D2 Port D D1 - D2	Option module digital output
Analog Input	Port A/B/C/D A1 - A4	A1 - A4	Port A A1 - A4 Port B A1 - A4 Port C A1 - A4 Port D A1 - A4	Option module analog input
Analog Output	Port A/B/C/D Q1 - Q2	S1 - S6	Port A Q1 - Q2 Port B Q1 - Q2 Port C Q1 - Q2 Port D Q1 - Q2	Option module analog output

NOTE: When configuring your meter, the configuration interface may show all of the possible ports, regardless of what is physically available on your meter.

See the ION Reference, available from www.schneider-electric.com for more information about ION modules.

Related Topics

- Option modules overview

I/O option modules

I/O option modules provide increased digital and analog input/output (I/O) capabilities for your meter.

⚠ WARNING
UNINTENDED OPERATION
Do not use the meter for critical control or protection applications where human or equipment safety relies on the operation of the control circuit.
Failure to follow these instructions can result in death, serious injury, or equipment damage.

These I/O modules can be used to monitor the status of breakers, control analog or digital transducers, or receive signals that can be interpreted to provide WAGES data for your energy system. For applications requiring high accuracy, such as energy pulsing to verify accuracy, the digital output on the meter base is recommended.

Your meter's digital and analog outputs may change state during a firmware upgrade. Option modules are offline during an option module firmware upgrade; they will not communicate to the meter and the outputs may change state during the upgrade process.

Your meter's analog I/O option modules can measure and output either low voltage or current using standard analog transducers such as 4 - 20 mA current transducers.

Analog I/O option module data viewing

View analog I/O option module data from the webpages and display.

To view analog option module data on your meter's display, go to **Inputs/Outputs** and select either **Analog Inputs** or **Analog Outputs**. If there are no I/O of the specified type, an informative message is displayed.

To view analog option module data on your meter's webpages, connect to your meter's webpages, go to **Monitoring > Inputs/Outputs** and select either **Analog Inputs** or **Analog Outputs**. If there are no I/O of the specified type, an informative message is displayed.

Digital I/O option module data viewing

View digital I/O option module data from the webpages and display.

To view digital option module data on your meter's display, go to **Inputs/Outputs** and select either **Digital Inputs** or **Digital Outputs**. If there are no I/O of the specified type, an informative message is displayed.

To view digital option module data on your meter's webpages, connect to your meter's webpages, go to **Monitoring > Inputs/Outputs** and select either **Digital Inputs** or **Digital Outputs**. If there are no I/O of the specified type, an informative message is displayed.

Analog inputs

Analog input applications

You can use an analog input to monitor an analog flowmeter to monitor how much water flows through a pipe.

For analog input operation, your meter takes an analog input signal and provides the resulting scaled value.

Your meter's analog I/O option modules can measure either low voltage or current using standard analog transducers such as 4 - 20 mA current transducers.

Related Topics

- Specifications

Analog input voltage and current mode

You can set the analog input's mode for voltage or current sensing.

In current mode, the analog inputs have a low input resistance while the meter is powered on, and a high input resistance when the meter is powered off. In voltage mode, the analog inputs have a high input resistance regardless of whether the meter is powered or not.

NOTE: When unpowered, your meter's analog inputs act like they are in voltage mode (high input resistance).

When connected to a current output transducer, this high resistance can create a high voltage. Standard (i.e., 4 to 20 mA) current transducers have open circuit protection and are able to handle a high input resistance; however, if non-standard transducers are used high voltages may be generated. Your meter's analog input has circuitry to limit this voltage, but it may not be sufficient with a very high-power current source.

NOTICE

EQUIPMENT DAMAGE

- Ensure the analog input is configured for the correct voltage or current mode before connecting or activating the current transducer.
- Do not exceed the device's ratings for maximum limits.

Failure to follow these instructions will result in equipment damage.

Related Topics

- Specifications

Analog input behavior

Analog inputs may show a value below zero scale if an open circuit is detected on the input port.

Analog input zero scale and full scale values

Configure your analog input's zero and full scale values.

In most cases the output range of the sensor feeding the analog input matches the hardware limits of your meter's analog input port. In that case, the analog input's zero scale and full scale values are the same as the sensor's represented range. For example:

Analog sensor	Meter's analog input	Analog input values
0 - 50 psi represented by a 4 - 20 mA signal	4 - 20 mA analog input range	Full scale = 50 (psi) Zero scale = 0 (psi)

If the sensor's output range does not match your meter's hardware limits, you must calculate the full scale and/or zero scale values by analyzing the system.

See the ION Reference, available from www.schneider-electric.com, for detailed information about the Analog Input module and full scale and zero scale calculations.

Configuring option module analog inputs using ION Setup

You can configure analog inputs using ION Setup.

Analog inputs are available on the optional I/O modules you can connect to the base of your meter.

Calculate your zero scale and full scale values based on the analog source and the input range of your meter.

Make sure that the analog input port that you want to use is properly configured and connected to a valid external analog signal source.

1. Start ION Setup.
2. Open the Setup Assistant for your meter.
3. Navigate to **Expansion Module > Option I/O Modules** and select the module tab that corresponds to the option module with the analog input you want to configure.
4. Select the analog input channel and click **Edit**. The setup screen for that analog input is displayed.
5. Configure the analog input by selecting the parameter and clicking **Edit**.

Parameter	Value/Range	Description
Zero scale	0 to $\pm 10^9$	The minimum source value that matches the minimum analog input signal.
Full scale	0 to $\pm 10^9$	The maximum source value that matches the maximum analog input signal.
Port	–	The physical analog input port connection.
Mode	Voltage, current	Determines whether the analog input is monitoring voltage or current.

Analog outputs

Analog output applications

You can use an analog output to send a signal to an analog-controlled valve to modify a water pipe's valve position in order to change the flow rate.

For analog output operation, your meter takes an input value and scales it to the appropriate signal value to send out the physical analog output port.

Your meter's analog I/O option modules can output either low voltage or current using standard analog transducers such as 4 - 20 mA current transducers.

Related Topics

- Specifications

Analog output behavior

Your meter's analog output, once configured, outputs voltage or current signals. If your meter's analog output source becomes unavailable (N/A) the analog output level should go to zero (0 V / 0 mA) under most conditions.

When your meter is powered off or configured to send voltage, the meter registers as a high impedance.

The electrical signal on the analog output is DC; make sure proper polarity is observed when wiring external devices to the analog output ports.

An unexpected change of state of the analog outputs can result when the supply power to the meter is interrupted, during an upgrade of the meter's firmware or framework or option module firmware or a during an option module reset.

⚠ WARNING
<p>UNINTENDED OPERATION</p> <p>Do not use this device for critical control or protection applications where human or equipment safety relies on the operation of the control circuit.</p> <p>Failure to follow these instructions can result in death, serious injury, or equipment damage.</p>

Analog output zero scale and full scale values

Configure your analog output's zero and full scale values.

In most cases your meter's analog output range matches the range of the analog sensors that your meter's outputs are connected to. In that case, your meter's analog output zero scale and full scale values are the maximum and minimum values of the source driving your meter's analog output. These values are used to normalize the source value to a value between 0 and 1 which is applied to the operating range of the analog output port to determine the analog output current or voltage. For example:

Source value	Analog output values	Meter's analog output	Analog sensor
0 to 120 kW range 100 kW	Full scale = 120 (kW) Zero scale = 0 (kW) Normalized: 0.83	4 - 20 mA range Output: 17.28 mA	4 - 20 mA range

If your meter's analog output range does not match the range of the connected analog sensor, you must calculate the full scale and zero scale values by analyzing the system.

See the ION Reference, available from www.schneider-electric.com for detailed information about the Analog Output module and full scale and zero scale calculations.

Configuring option module analog outputs using ION Setup

You can configure option module analog outputs using ION Setup.

Analog outputs are available on the optional I/O modules you can connect to the base of your meter.

Calculate your zero scale and full scale values based on the measured value and the analog output range of your meter.

Make sure that the analog output port that you want to use is properly connected to an analog receiver.

1. Start ION Setup.
2. Open the Setup Assistant for your meter.
3. Navigate to **Expansion Module > Option I/O Modules** and select the module tab that corresponds to the option module with the analog output you want to configure.
4. Select the analog output channel and click **Edit**. The setup screen for that analog output is displayed.
5. Configure the analog output by selecting the parameter and clicking **Edit**.

Parameter	Value/Range	Description
Zero scale	0 to $\pm 10^9$	The minimum source value that matches the minimum analog output signal.
Full scale	0 to $\pm 10^9$	The maximum source value that matches the maximum analog output signal.
Port	–	The physical analog output port connection.
Mode	Voltage, current	Determines whether the analog output is monitoring voltage or current.

Digital inputs

Digital input applications

Digital inputs are typically used for monitoring the status of contacts, such as status contacts on circuit breakers.

They can also be used for pulse counting or input metering applications, such as WAGES (water, air, gas, electricity, steam) monitoring, or conditional energy applications, or IRIG-B time synchronization.

IRIG-B time synchronization

You can use a digital input to synchronize the meter time to an IRIG-B time source.

You can connect an IRIG-B time source to one of meter's digital inputs for IRIG-B time synchronization; for improved accuracy use the digital inputs on the meter base. For IRIG-B time synchronization, you must configure both the meter's digital input and the meter's clock.

Related Topics

- Configuring time and time synchronization using ION Setup

Configuring onboard digital inputs using ION Setup

You can use ION Setup to configure your meter's digital inputs.

Digital inputs are available on your meter. You can add more digital inputs using optional I/O modules.

1. Start ION Setup.
2. Open the Setup Assistant for your meter.
3. Navigate to **I/O > Digital Inputs**. The tabs correspond to each digital input. Click on the tab for the digital input you want to edit.
4. Configure the digital input by selecting the parameter and clicking **Edit**.

- Once the parameter has been configured, click **OK** to save the setting to the meter.

Parameter	Value/range	Description
Input Mode	Pulse, KYZ, A/C, IRIG-B ¹	Specifies how the meter processes the signal: <ul style="list-style-type: none"> Pulse: the meter counts an entire pulse (from off-on to on-off) as one input. KYZ: the meter counts a transition (from off-on or from on-off) as one input. A/C: the meter detects analog signals where the ON condition is based on the presence of an AC signal IRIG-B¹: the meter detects an IRIG-B time synchronization signal.
Polarity	Inverting/Non-Inverting	Specifies if the signal from the digital port is inverted or not inverted.
Debounce	0.000 - 1.000	Specifies how long (in seconds) the signal must remain in a state to be considered a valid state change.
Port	Defined by your meter's hardware	Your meter's physical digital input port.

¹ IRIG-B can only be connected to one of the digital inputs located on the meter base, not an option module. You must also configure your meter's clock to use IRIG-B time synchronization.

Configuring option module digital inputs using ION Setup

You can configure option module digital inputs using ION Setup.

Digital inputs are available on your meter. You can add more digital inputs using optional I/O modules.

- Start ION Setup.
- Open the Setup Assistant for your meter.
- Navigate to **Expansion Module > Option I/O Modules** and select the module tab that corresponds to the option module with the digital input you want to configure.
- Select the digital input channel and click **Edit**. The setup screen for that digital input is displayed.
- Configure the digital input by selecting the parameter and clicking **Edit**.
- Once the parameter has been configured, click **OK** to save the setting to the meter.

Parameter	Value/Range	Description
Input Mode	Pulse, KYZ, A/C, IRIG-B ¹	Specifies how the meter processes the signal: <ul style="list-style-type: none"> Pulse: the meter counts an entire pulse (from off-on to on-off) as one input. KYZ: the meter counts a transition (from off-on or from on-off) as one input. A/C: the meter detects analog signals where the ON condition is based on the presence of an AC signal. IRIG-B¹: the meter detects an IRIG-B time synchronization signal.
Polarity	Inverting/Non-Inverting	Specifies if the signal from the digital port is inverted or not inverted.
Debounce	0.000 - 1.000	Specifies how long (in seconds) the signal must remain in a state to be considered a valid state change.
Port	Defined by your meter's hardware	Your meter's physical digital input port.

¹ IRIG-B can only be connected to one of the digital inputs located on the meter base, not an option module.

WAGES monitoring

WAGES monitoring allows you to record and analyze all energy sources and utilities usage.

Your energy system may use several different types of energy. For example, you may consume steam or compressed air for industrial processes, electricity for lights and computers, water for cooling and natural gas for heating. WAGES monitoring collects the usage information from all these different energy sources to enable a more complete energy analysis.

WAGES information can help you:

- Identify losses or inefficiencies.
- Modify demand to reduce costs.
- Optimize energy source usage.

WAGES example

This example shows WAGES monitoring for a water flow meter.

You can connect your meter’s digital input to a transducer that sends a pulse for every 15 kiloliters (4000 US Gal) of water. After configuring an input metering channel and assigning it to the digital input, the meter is able to detect and record the incoming pulses. An energy management system can then use the information from the meter to perform WAGES analysis.

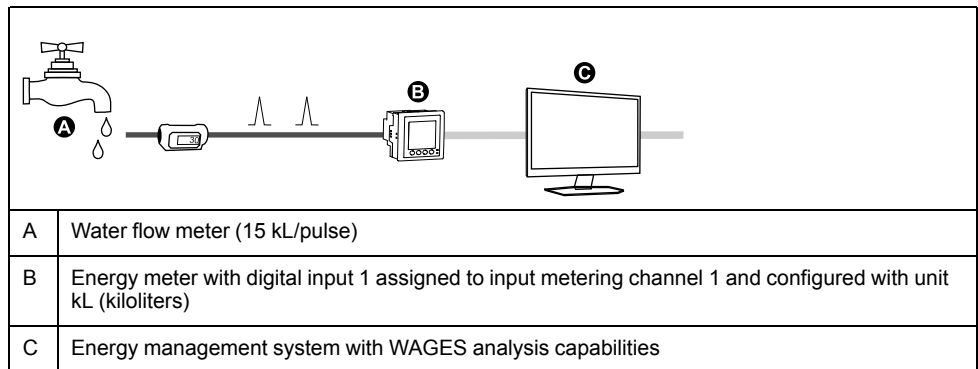

Input metering

Your meter’s digital inputs can be used to count pulses from transducers and convert the pulses to energy measurements.

Your meter’s input metering channels count pulses received from the digital inputs assigned to that channel. The incoming pulses are used in calculating and measuring consumption data (e.g., BTU, kWh, L, kg). Each channel must have the following values configured to match the pulse data:

- Pulse Weight: the pulses per unit value.
- Unit Code: the unit of measure associated with the monitored value.
- Demand Code: for time-based values (such as kWh), this provides the associated demand units (kW) for demand calculations; for other values (such as kg), this can be configured to provide rate information (kg/h or kg/s).
- Mode: whether a pulse is based on a complete pulse or a transition.

For example, if each complete pulse represents 125 Wh, you can configure for Wh pulsing as follows:

- Pulse Weight = pulses/Wh = 1/125 = 0.008
- Unit Code = Wh
- Demand Code = kW (this is automatically set)
- Mode = pulse

If you want to configure for kWh pulsing, you must adjust the pulse weight calculation and unit code as follows:

- Pulse Weight = pulses/kWh = $1/0.125 = 8$
- Unit Code = kWh

Configuring standard input metering using ION Setup

You can configure input metering with standard units and rates using ION Setup

When configuring your meter, the configuration interface may show all of the possible ports, regardless of what is physically available on your meter.

NOTE: Your device's digital input must be connected to the input metering pulse source. Review the digital inputs assigned to applications to help you understand your existing configuration.

1. Start ION Setup.
2. Open the Setup Assistant for your meter.
3. Navigate to **Energy Applications > Digital Input Based**.
4. Select the input metering channel you want to configure and click **Edit**. The **Input Metering Channel Setup** screen is displayed.
5. Select **Enabled** to enable the input metering feature.
6. Click **Select** to define which digital input is the pulse source for the input metering channel.

NOTE: It is recommended to set **Assigned Input** to No connection to disable the input metering channel by removing any port associations.

7. Configure the remaining parameters as required.
8. Click **OK** to save your configuration.
9. Configure your meter to log the input metering data if required.

Parameter	Description
Pulse Weight	Enter the value per pulse.
Units	Select the measurement units associated with the pulse.
Demand Period	Enter the frequency in minutes that input metering data is calculated in your energy management system.
Rate	Select the rate associated with the defined Units.
Source ID	Enter a data identifier. This value is added to the input metering channel's data to uniquely identify the data within your energy management system.

Configuring custom input metering using ION Setup

You can configure input metering with custom units and rates using ION Setup.

When configuring your meter, the configuration interface may show all of the possible ports, regardless of what is physically available on your meter.

NOTE: Your device's digital input must be connected to the input metering pulse source. Review the digital inputs assigned to applications to help you understand your existing configuration.

1. Start ION Setup.
2. Open the Setup Assistant for your meter.
3. Navigate to **Energy Applications > Digital Input Based**.
4. Select the input metering channel you want to configure and click **Edit**. The **Input Metering Channel Setup** screen is displayed.

5. Select **Enabled** to enable the input metering feature.
6. Click **Select** to define which digital input is the pulse source for the input metering channel.

NOTE: It is recommended to set **Assigned Input** to No connection to disable the input metering channel by removing any port associations.
7. Clear the **Standard quantity** checkbox. The screen changes to display custom input metering parameters.
8. Configure the remaining parameters as required.
9. Click **OK** to save your configuration.
10. Configure your meter to log the input metering data if required.

Parameter	Description
Pulse Weight	Enter the value per pulse.
Units	Select the measurement units associated with the pulse. NOTE: Include source identification information by entering "@" followed by the source identifier.
Demand Period	Enter the frequency in minutes that input metering data is calculated in your energy management system.
Rate	Select the rate associated with the defined Units.
Scaling	Select the scaling value based on the relationship between Units and Rate.
Time Base	Select the value and units to match the Rate.

Digital outputs

Digital output applications

Digital outputs are typically used in switching applications, for example, to provide on/off control signals for switching capacitor banks, generators, and other external devices and equipment.

The digital output can also be used in demand synchronization applications, where the meter provides pulse signals to the input of another meter to control its demand period. The digital output can also be used in energy pulsing applications, where a receiving device determines energy usage by counting the kWh pulses coming from the meter's digital output port.

Related Topics

- Specifications

Configuring onboard digital outputs using ION Setup

You can use ION Setup to configure your meter's digital outputs.

One form A digital output is available on the base of the meter. You can add more digital outputs using optional I/O modules.

1. Start ION Setup.
2. Open the Setup Assistant for your meter.
3. Navigate to either onboard or expansion I/O, Digital Outputs, and select a digital output tab.

4. Configure the digital output by selecting the parameter and clicking **Edit**.

Parameter	Value/range	Description
Source	Digital/Boolean	Link this input to the value that drives the state of the digital output. If Source is not linked, the digital output state is driven by the Force ON, Force OFF values.
Force ON	Pulse	Link this input to a pulse that forces the digital output on for the PulseWidth duration, regardless of the Source input.
Force OFF ¹	Pulse	Link this input to a pulse that forces the digital output off.
Normal ¹	Pulse	Pulsing this input will switch the driver of the digital output from Force ON to Source.
Polarity	Inverting/non-inverting	Specifies if the signal to the digital port is inverted or not inverted.
PulseWidth	0 - 2,000,000	Specifies the duration of the pulse, in seconds. Setting this parameter to 0 sets the digital output continuously on.
Port	—	The physical digital output port connection. Only available ports are shown.

¹ These parameters are only valid when pulse width is set to 0.

Configuring option module digital outputs using ION Setup

You can configure option module digital outputs using ION Setup.

One form A digital output is available on the base of the meter. You can add more digital outputs using optional I/O modules.

1. Start ION Setup.
2. Open the Setup Assistant for your meter.
3. Navigate to **Expansion Module > Option I/O Modules** and select the module tab that corresponds to the option module with the digital output you want to configure.
4. Select the digital output channel and click **Edit**. The setup screen for that digital output is displayed.
5. Configure the digital output by selecting the parameter and clicking **Edit**.

Parameter	Value/Range	Description
Source	Digital/Boolean	Link this input to the value that drives the state of the digital output. If Source is not linked, the digital output state is driven by the Force ON, Force OFF values.
Force ON	Pulse	Link this input to a pulse that forces the digital output on for the PulseWidth duration, regardless of the Source input.
Force OFF ¹	Pulse	Link this input to a pulse that forces the digital output off.
Normal ¹	Pulse	Pulsing this input will switch the driver of the digital output from Force ON to Source.
Polarity	Inverting/non-inverting	Specifies if the signal to the digital port is inverted or not inverted.
PulseWidth	0 - 2,000,000	Specifies the duration of the pulse, in seconds. Setting this parameter to 0 sets the digital output continuously on.
Port	—	The physical digital output port connection. Only available ports are shown.

¹ These parameters are only valid when pulse width is set to 0.

Energy pulsing

You can configure the meter’s energy pulsing LEDs, optical port or digital output for energy pulsing applications.

When an LED or output is set to energy pulsing, the meter sends a readable pulse or signal based on the measured energy source value. This pulse can be used for accuracy verification or as an input to another energy monitoring system.

Default energy pulsing LED sources

Your meter’s energy pulsing LEDs have default energy source values configured for accuracy verification testing.

LED	Location	Default energy pulsing source
Top LED	Top of meter body	kW del+rec
WATT LED	Front of integrated display	kW del+rec
VAR LED	Front of integrated display	kVAR del+rec
Optical port	Front of integrated display	kW del+rec

NOTE: To modify your default energy source value, go into the advanced mode of ION Setup and modify the associated Calibration Pulser module. This is an advanced procedure that should only be performed if you have advanced knowledge of ION and the power system your meter is connected to.

See the *ION Reference*, available from www.schneider-electric.com, for more information.

Configuring LED energy pulsing using ION Setup

You can configure your meter’s energy pulsing LEDs and your meter’s optical port for energy pulsing using ION Setup.

1. Start ION Setup.
2. Open the Setup Assistant for your device.
3. Select **LED pulsing**.
4. Select the tab that corresponds to the energy pulsing LED you want to configure:

Option	Description
Top LED	Visible and infrared LEDs located on the top of the meter. These energy pulsing LEDs are available on all meters (with or without integrated display).
WATT LED	Visible and infrared LEDs located on the meter’s integrated display labeled WATT.
VAR LED	Visible and infrared LEDs located on the meter’s integrated display labeled VAR.
Optical Port	Optical port located on the meter’s integrated display. NOTE: To use your meter’s optical port for energy pulsing, you must set the optical port’s protocol to Infrared I/O .

- Configure the following basic parameters for your meter’s energy pulsing LEDs.

Energy pulsing LED parameters available through ION Setup

Parameter	Description
Kt	The amount of source energy required to make the LED pulse.
Pulse Width	The minimum time in seconds between LED pulse transitions. NOTE: There is a minimum 50% duty cycle on all pulses.
Pulser Mode	Select when the energy pulsing LEDs will pulse: <ul style="list-style-type: none"> Always: the energy pulsing LEDs are always pulsing based on their energy source value. Test Only: the energy pulsing LEDs will only pulse when the meter is in test mode.
Pulse ovrld	Pulsing normally indicates that the energy pulsing LED should be operating normally. Pulsing suspended indicates that the energy pulsing LED is not able to pulse quickly enough. Modify the Kt value to decrease the number of energy pulses.

NOTE: To perform specialized configuration go into the advanced mode of ION Setup and modify or add a new Calibration Pulser module. This is an advanced procedure that should only be performed if you have advanced knowledge of ION and the power system your meter is connected to.

See the *ION Reference*, available from www.schneider-electric.com, for more information.

Configuring digital output energy pulsing using ION Setup

You can configure your meter’s digital output for energy pulsing using ION Setup

Ensure that the digital output port is available for energy pulsing and not associated with another function.

When configuring your meter, the configuration interface may show all of the possible ports, regardless of what is physically available on your meter.

NOTE: For applications where accuracy is important, use the digital output located on the base of the meter.

- Start ION Setup.
- Open the Setup Assistant for your device.
- Select **Energy pulsing**.

- Select an energy pulsing source tab (such as Wh Del) to configure energy pulsing using your meter's digital output.

Digital output energy pulsing parameters available through ION Setup

Parameter	Description
Kt	The amount of energy source required to trigger the digital output. For example, in the Wh Del tab, the Kt value would be amount of real energy delivered (Wh Del) per pulse.
Pulse Width	The minimum time in seconds between pulse transitions. NOTE: There is a minimum 50% duty cycle on all pulses.
OutputMode	Select the desired output mode: <ul style="list-style-type: none"> Pulse: the digital output sends a complete pulse when triggered. KYZ: the digital output makes a transition (off to on, or on to off) when triggered.
Port	Select an output port from the list. Only available output ports are shown (ports that are not associated with another function).
(energy source) ovrld	Pulsing normally indicates that the output port should be operating normally. Pulsing suspended indicates that the output port is not able to pulse quickly enough. Modify the Kt value to decrease the number of energy pulses.

NOTE: To perform specialized configuration go into the advanced mode of ION Setup and modify or add a new Calibration Pulser module. This is an advanced procedure that should only be performed if you have advanced knowledge of ION and the power system your meter is connected to.

See the *ION Reference*, available from www.schneider-electric.com, for more information.

Calculate your maximum kWh/pulse (pulse weight) value

To calculate the kWh/pulse (pulse weight) value, divide the highest kW value you can expect by the required pulse rate.

Make sure the required pulse rate does not exceed the maximum pulse rate for the digital output.

NOTE: To convert from kWh/pulse to pulse/kWh you must invert (take the reciprocal) of the value. For example, 1.8 kWh/pulse becomes 0.556 pulse/kWh.

Example pulse weight calculation

For a maximum load of 1600 kW and a pulse rate of 2 pulses per second, calculate the kWh/pulse value as follows:

- Convert 1600 kW load into kWh/second:

$$(1600 \text{ kW}) \times (1 \text{ hr}) = 1600 \text{ kWh}$$

$$(1600 \text{ kWh}) / (3600 \text{ sec}) = (X \text{ kWh}) / (1 \text{ sec})$$

$$X = 0.444 \text{ kWh/sec}$$

- Calculate the kWh required per pulse:

$$(0.444 \text{ kWh/sec}) / (2 \text{ pulses per second}) = 0.222 \text{ kWh/pulse}$$

- Adjust for the KY giving one pulse per 2 transitions if necessary.

$$(0.222 \text{ kWh/pulse}) / (2) = 0.111 \text{ kWh/pulse}$$

Alarms and alerts

Alarms overview

An alarm is the meter's means of notifying you when an alarm condition is detected, such as an error or an event that falls outside of normal operating conditions.

You can configure your meter to generate and display high, medium and low priority alarms when predefined events are detected in the meter's measured values or operating states. Your meter also logs the alarm event information. Your meter comes with many alarms. Some alarms are preconfigured, while others need to be configured before your meter can generate alarms. Your meter's default alarms can be customized, as needed, such as changing the priority. You can create custom alarms using the advanced features of your meter.

Alarm types

Your meter has four types of alarms.

Type	Description
Setpoint (standard)	Setpoint alarms define an alarm by comparing the actual value of a parameter to a specified limit or range of values. These include measured voltage and current values and calculated power quality values. Some setpoint alarms use high-speed measurements for up to 1 millisecond resolution.
Digital	Digital alarms define an alarm condition based on a digital input's on/off state.
Disturbance (sag/swell)	Disturbance alarms define an alarm based on a measured sag or swell.
Unary	Unary alarms are not configurable, and generate an alarm based on the meter's state, for example, the meter powering up.

Alarms have two states:

- Active: the meter detects the alarm condition is met.
- Historical: the alarm condition previously existed but the condition has since returned to a non-alarm state.

See the *ION reference*, available from www.schneider-electric.com, for more information about Setpoint, Digital Input and Sag/Swell modules.

Standard alarms

Standard alarms are setpoint-driven alarms monitor certain behaviors, events or unwanted conditions in your electrical system.

Standard alarms have a detection rate equal to the 50/60 meter cycle, which is nominally 1 second if the meter's frequency setting is configured to match the system frequency (50 or 60 Hz).

Many of the standard alarms are three-phase alarms. Alarm setpoints are evaluated for each of the three phases individually, but the alarm is reported as a single alarm. The alarm pickup occurs when the first phase exceeds the alarm pickup magnitude for the pickup time delay. The alarm is active as long as any phase remains in an alarm state. The alarm dropout occurs when the last phase drops below the dropout magnitude for the dropout time delay.

Example of over and under setpoint (standard) alarm operation

The meter supports over and under setpoint conditions on standard alarms.

A setpoint condition occurs when the magnitude of the signal being monitored crosses the limit specified by the pickup setpoint setting and stays within that limit for a minimum time period specified by the pickup time delay setting.

The setpoint condition ends when the magnitude of the signal being monitored crosses the limit specified by dropout setpoint setting and stays within that limit for a minimum time period specified by dropout time delay setting.

Over setpoint

When the value rises above the pickup setpoint setting and remains there long enough to satisfy the pickup time delay period ($\Delta T1$), the alarm condition is set to ON. When the value falls below the dropout setpoint setting and remains there long enough to satisfy the dropout time delay period ($\Delta T2$), the alarm condition is set to OFF.

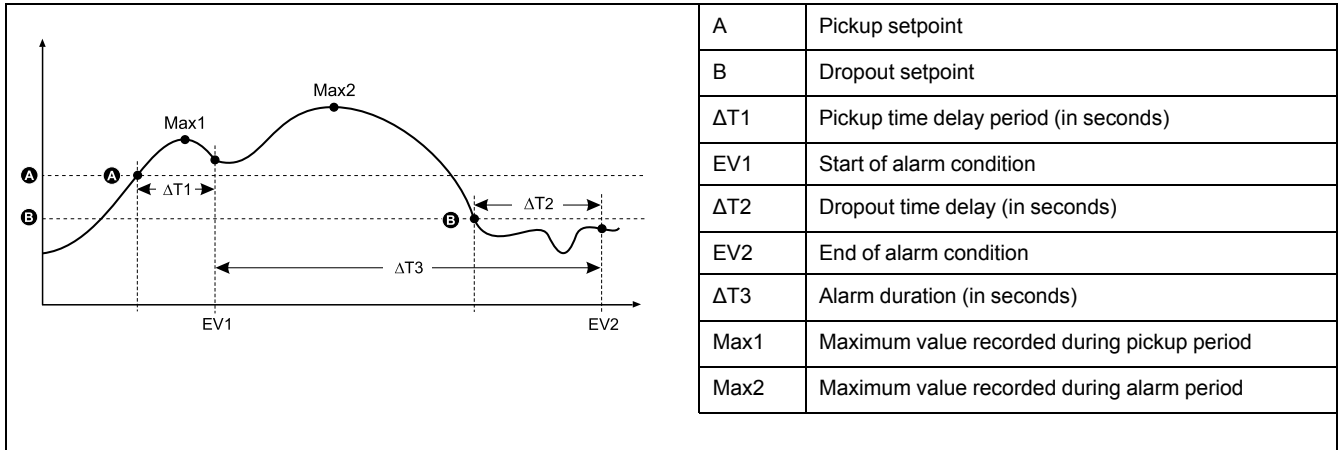

The meter records the date and time when the alarm event starts (EV1) and when it ends (EV2). The meter also performs any task assigned to the event, such as operating a digital output. The meter also records maximum values (Max1, Max2) before, during or after the alarm period.

Under setpoint

When the value falls below the pickup setpoint setting and remains there long enough to satisfy the pickup time delay period ($\Delta T1$), the alarm condition is set to ON. When the value rises above the dropout setpoint setting and remains there long enough to satisfy the dropout time delay period ($\Delta T2$), the alarm condition is set to OFF.

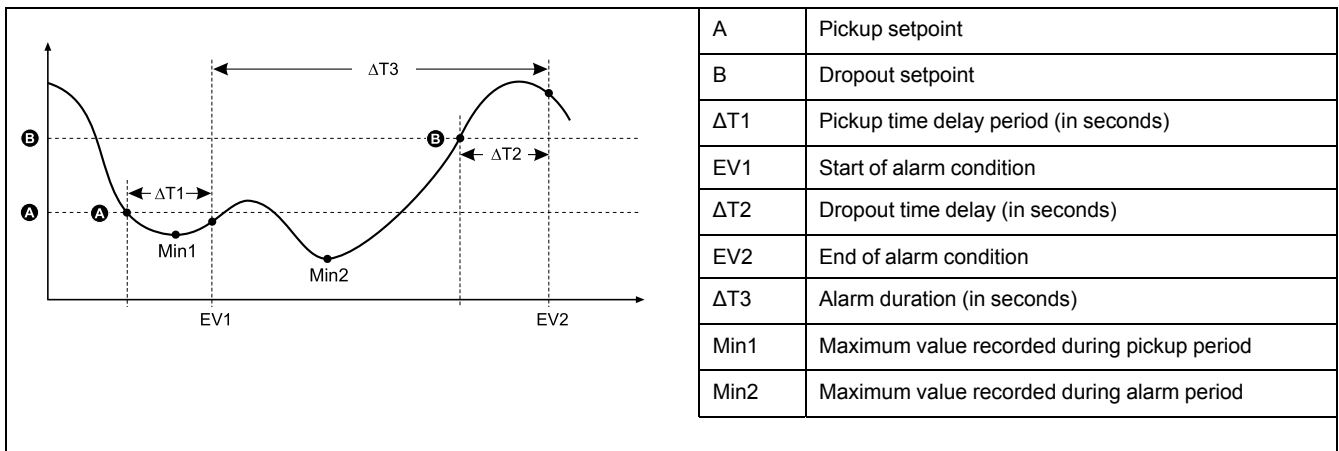

The meter records the date and time when the alarm event starts (EV1) and when it ends (EV2). The meter also performs any task assigned to the event, such as operating a digital output. The meter also records minimum values (Min1, Min2) before, during or after the alarm period.

Disturbance (sag/swell) alarms

These alarms are triggered by voltage and current disturbances.

You must configure nominal voltage and current for these alarms to function.

For voltage disturbances, enter the percentage deviation from the nominal that defines a sag or swell.

For current disturbances, enter the percentage deviation from the nominal that defines the pickup and dropout points for a current sag or a current swell.

Digital alarms

These alarms are triggered when the associated digital input changes state.

You can configure the alarm to be active when the digital input is on or off, depending on the alarm's purpose.

For example, if you used a digital input to monitor a breaker that is always supposed to be on, you would set the alarm to be active when the breaker has tripped.

NOTE: To stop a digital alarm from being displayed, set the alarm priority to info only. Disabling (force off) the digital alarm off will disable all functions of the associated digital input.

See the ION Reference, available from www.schneider-electric.com, for more information about the Setpoint and Relative Setpoint module, Digital Input module, Sag/Swell module and Disturbance Analyzer modules.

Related Topics

- Configuring sag/swell alarms using ION Setup

Alarm event priorities

Your meter's alarm priorities correspond to event priority ranges.

Alarm priority	Event priority
High (red)	192 - 255
Medium (yellow)	128 - 191
Low (blue)	64 - 127
Info only (no alarm) ¹	1 - 63
None (no alarm or event) ¹	0

¹ Alarms with priority of info only or none are not indicated or displayed.

Info only and none event priority

Alarms with a priority of info only or none are not shown on the meter's display, and do not function as alarms. If the alarm's priority is set to info only, and the event priority is greater than the event log cutoff value, the associated event is recorded in the meter's event log. If the alarm's priority is set to none, the event priority is automatically set to zero, and no associated event is logged in the meter's event log.

For events that you want to log for future reference or troubleshooting, but don't want alarm functions, set the alarm priority to info only.

For nuisance events that frequently occur and you have no desire to log for reference or troubleshooting, set the alarm priority to none.

Related Topics

- Event log overview

Alarm indicators

Your meter's display has an alarm indicator to show you what alarm levels have been detected (active or historic) and whether they have been acknowledged.

For active high priority alarms, the meter's display will also flash until the alarm is acknowledged. There is also an alarm LED to indicate the meter's alarm condition.

Alarm	Alarm icon	Alarm icon flash	Alarm LED	Meter display
Active high	Red solid bell	Flash if not acknowledged	<ul style="list-style-type: none"> • Flash if not acknowledged • Steady if acknowledged 	Flash if not acknowledged
Active medium	Yellow solid bell	Flash if not acknowledged	<ul style="list-style-type: none"> • Flash if not acknowledged • Steady if acknowledged 	No flash
Active low	Blue solid bell	Flash if not acknowledged	<ul style="list-style-type: none"> • Flash if not acknowledged • Steady if acknowledged 	No flash
Historic high	Red outline bell	Flash if not acknowledged	<ul style="list-style-type: none"> • Flash if not acknowledged • Steady if acknowledged 	No flash
Historic medium	Yellow outline bell	Flash if not acknowledged	<ul style="list-style-type: none"> • Flash if not acknowledged • Steady if acknowledged 	No flash
Historic low	Blue outline bell	Flash if not acknowledged	<ul style="list-style-type: none"> • Flash if not acknowledged • Steady if acknowledged 	No flash
No active or unacknowledged alarms	Gray solid bell	No flash	Off	No flash

If there are multiple active alarms, the meter displays the alarm condition associated with the most important active alarm. If there are multiple unacknowledged historic alarms, the meter displays the alarm condition associated with the most important unacknowledged historic alarm.

NOTE: To stop an alarm from being displayed without impacting other metering features, set the alarm priority to info only.

Default alarms

Your meter comes with default alarms.

NOTE: Some alarms require configuration in order to operate.

Name	Priority	Description
Current Sag Ph1 - 3	High	Current sag alarms for phase 1, 2, 3
Current Swell Ph1 - 3	High	Current swell alarms for phase 1, 2, 3
Sag/Swell	High	Voltage sag/swell alarm
Over I unbal	Medium	Over unbalanced current alarm
Over V unbal	Medium	Over unbalanced voltage alarm

Name	Priority	Description
Over THD V1 - 3	Medium	Over total harmonic distortion (THD) voltage alarms
Over kW (P) sd	Medium	Over kW sliding demand alarm
Over I a - c, (1 -3) 4	Medium	Over current alarms
V1 - V3 Setpoint	Medium	Voltage setpoint alarms
Freq Setpoint	Medium	Frequency setpoint alarm
4-30 Volt Intrap Ph1 - 3	Low	4-30 voltage interruption power quality alarms
Digital In	Info only	Digital input alarms Number of alarms determined by the total number of available digital inputs NOTE: These alarms are not displayed by default.

Alarm information

You can view information about an alarm from your meter's display.

Only alarms with a priority of low, medium or high are displayed.

Parameter	Description
Alarm	The name of the alarm (for example, Over THD V1).
Priority	Low, medium or high alarm priority.
Date	The date and time the alarm was triggered.
Duration	The duration of the alarm (only applies to inactive alarms).
Ack	The date and time when the alarm was acknowledged (only applies to acknowledged alarms).
Value	Active alarm: The maximum value detected when the alarm was triggered. Historic alarm: The maximum value detected during the duration of the alarm.

Viewing and acknowledging alarms using the meter's display

You can view and acknowledge alarms using your meter's display

1. Press the home button to display your meter's data screen menu.
2. Navigate to **Alarms > Active Alarms** to view and acknowledge active alarms, or navigate to **Alarms > Historic Alarms** to view and acknowledge alarms that are no longer active.
3. Use the up and down arrows to view the different alarms. Press the info button to view details of the selected alarm.
4. To acknowledge all active or historic alarms, press the up and down arrow button simultaneously. A green checkmark appears by the acknowledged alarms, and the alarm indicators are updated.

Alarm configuration

Disabling alarms through your meter's display

You can disable alarms through the meter's display when you are performing maintenance tasks on your system and want to prevent nuisance alarms.

NOTE: To stop an alarm from being displayed without impacting other metering features, set the alarm priority to info only.

⚠ WARNING
<p>INACCURATE DATA RESULTS</p> <p>Confirm your alarm is properly configured.</p> <p>Failure to follow these instructions can result in death, serious injury, or equipment damage.</p>

1. Navigate to **Setup Menu > Alarm Setup**. Press the edit button to access the enable/disable screen. Use the up and down arrows to scroll through the available alarms. Simultaneously press the up and down arrow to enable or disable the highlighted alarm.
2. Press the select button to confirm your settings.
3. Complete the system maintenance tasks.
4. Enable the alarms you disabled in step 1.

Related Topics

- Meter setup using your meter’s display

Alarm setup

You can disable alarms through the display in order to prevent nuisance alarms.

Alarm setup

⚠ WARNING
<p>INACCURATE DATA RESULTS</p> <p>Do not use data displayed on the display or in software as a substitute for proper workplace practices or equipment maintenance.</p> <p>Failure to follow these instructions can result in death, serious injury, or equipment damage.</p>

Parameter ¹	Description
Over I unbal	Over unbalanced current alarm
Over THD V1	V1 over total harmonic distortion (THD) voltage alarm
Over THD V2	V2 over total harmonic distortion (THD) voltage alarm
Over THD V3	V3 over total harmonic distortion (THD) voltage alarm
Over P sd	Over kW sliding demand alarm
Over Ia	Ia over current alarm
Over Ib	Ib over current alarm
Over Ic	Ic over current alarm
Over I4	I4 over current alarm
Over V unbal	Over unbalanced voltage alarm
V1 Setpoint	V1 setpoint alarm
V2 Setpoint	V2 setpoint alarm
V3 Setpoint	V3 setpoint alarm
Freq Setpoint	Frequency setpoint alarm
Sag/Swell 1	Voltage sag/swell alarm
Current Sag Ph1	Current sag alarms for phase 1

Parameter ¹	Description
Current Sag Ph2	Current sag alarms for phase 2
Current Sag Ph3	Current sag alarms for phase 3
4-30 Volt Intrap Ph1	4-30 voltage interruption power quality alarm for phase 1
4-30 Volt Intrap Ph2	4-30 voltage interruption power quality alarm for phase 2
4-30 Volt Intrap Ph3	4-30 voltage interruption power quality alarm for phase 3
Current Swell Ph1	Current swell alarms for phase 1
Current Swell Ph2	Current swell alarms for phase 2
Current Swell Ph3	Current swell alarms for phase 3

¹ Any Setpoint or Relative Setpoint module with an event priority greater than the low alarm event priority is also displayed on this screen.

You can only enable or disable alarms using the display. Alarm configuration is done using ION Setup. Alarms with a priority less than low (info only or none) are not displayed.

You must configure all the parameters related to the alarm for alarm functions to operate. For example, for the Over Ia alarm to operate, you must enter the nominal value and the conditions that define an alarm state, even if the alarm is shown as Enabled on the Alarm Setup screen.

Configuring setpoint/standard alarms using ION Setup

You can use ION Setup to configure the standard alarm settings.

1. Start ION Setup.
2. Open the Setup Assistant for your meter.
3. Navigate to **Alarming** and click the **Standard** tab.
4. Select a setpoint and click **Edit**.
5. Enter unit password and click **OK**, if required.

The **Setpoint Setup** screen is displayed.

6. Configure the setpoint values as required.
7. Click **Save** to save the settings to your meter.

Parameter	Value/Range	Description
By Percentage	By Percentage/By Value	When available, specifies if the Pickup and Dropoff entries are by percentage or by value. If the option is not available, pickup and dropoff entries are by value.
Force Off	Checked/Unchecked	Forcing the alarm off disables all functions of the associated input. To stop an alarm from being displayed without affecting other meter features, set the alarm priority to Info only.
Label	String value	When available, lets you modify the default label so it more clearly identifies the alarm. Letters, numbers, underscores are permitted. Spaces are not permitted.
Pickup	Numeric value	Use this setting to provide a value for when the alarm turns on.
Pickup Delay	Numeric value	This specifies the number of seconds the digital input must be in the alarm pickup state before the alarm turns on.
Dropout	Numeric value	Use this setting to provide a value for when the alarm turns off.
Dropout Delay	Numeric value	This specifies the number of seconds the digital input must be below the alarm dropoff state before the alarm turns off.
Alarm Priority	None, Info only, Low, Medium or High	Specifies the priority level of the standard alarm. To disable the alarm, set priority to Info only.
Custom Priority	0-255	Select custom priority to view and configure the event priority of the event associated with the alarm. The event log cutoff value is displayed for reference; priorities above the cutoff are stored in the meter's event log.

Implementing alarm setpoint learning using ION Setup

You can use ION Setup to implement setpoint learning, which analyzes your power system and recommends settings.

NOTE: Your meter's power system must be stable in order to learn valid setpoint values.

1. Start ION Setup.
2. Open the Setup Assistant for your meter.
3. Navigate to **Alarming > Standard**.

NOTE: You can manually configure setpoint values by selecting the setpoint and clicking **Edit**.

4. Select a setpoint and click **Learn**.

The **Global Setpoint Learning** screen is displayed.

5. Select the setpoint tabs to view existing configured or learned setpoint information.

6. Click **Setup**.

The **Alarm Learning Setup** screen is displayed.

7. Configure the learning parameters for each setpoint and click **Save**.

8. Click **Start All** to begin setpoint learning for all setpoints.

- When setpoint learning is in progress, an asterisk is displayed next to the setpoint.
- Click **Abort** to stop learning for a specific setpoint. To stop all setpoint learning, repeat for each setpoint tab.

9. Apply the learned setpoint values:

- Automatic: the setpoint values are automatically applied unless the learning process has issues or the learned values are invalid.
- Manual: navigate to **Alarming > Setpoints** and click **Learn**. On each setpoint tab, click **Install** to apply the learned values to that setpoint.

NOTE: If you click **Install** while learning is in progress (in either manual or automatic installation mode), it stops the learning process and prompts you for confirmation that you want to stop learning and install the learned values. Once you confirm, the learned values are automatically installed or prepared for manual installation.

Configuring sag/swell alarms using ION Setup

You can use ION Setup to configure the sag/swell alarm settings.

1. Start ION Setup.
2. Open the Setup Assistant for your meter.
3. Navigate to **Alarming > Sag/Swell**.
4. Select a parameter and click **Edit**.

5. Configure the parameters as required.

Parameter	Value/Range	Description
Nominal voltage	1 to 999,999	Specifies the nominal voltage value used for sag/swell detection.
Voltage Swell%	Percentage of nominal	Specifies the swell limit expressed as a percentage of the nominal voltage.
Voltage Sag%	Percentage of nominal	Specifies the sag limit expressed as a percentage of the nominal voltage.
Nominal Current	1 to 999,999	Specifies the nominal current value used for sag/swell detection.
I Sag Pickup	Numeric value	Specifies the percentage the current must deviate from the nominal current in order to be classified as a sag.
I Sag Dropout	Numeric value	Specifies the additional amount that the current must recover in order to signal the end of the sag.
I Swell Pickup	Numeric value	Specifies the percentage the current must deviate from the nominal current in order to be classified as a swell.
I Swell Dropout	Numeric value	Specifies the additional amount that the current must recover in order to signal the end of the swell.

Implementing sag/swell limit learning using ION Setup

You can use ION Setup to implement voltage sag/swell learning, which analyzes your power system and recommends settings.

NOTE: Your meter's power system must be stable in order to learn valid sag/swell limits.

1. Start ION Setup.
2. Open the Setup Assistant for your meter.
3. Navigate to **Alarming > Sag/Swell**.
4. Select **Voltage Swell %** or **Voltage Sag %** and click **Learn**. The **Global Setpoint Learning** screen is displayed.

NOTE: You can manually configure the limit values by selecting the parameter and clicking **Edit**.

5. Click **Setup**. The **Alarm Learning Setup** screen is displayed. Configure the learning parameters.

Click **Start** to begin sag/swell learning. Click **Abort** to stop learning.

6. Apply the learned sag/swell limits.
 - Automatic: the limits are automatically applied unless there are issues with the learning process.
 - Manual: navigate to **Power quality > Sag/Swell**. Select the **Swell limit %** or **Sag limit %** and click **Learn**. Click **Install** to apply the learned limits.

NOTE: If you click **Install** while learning is in progress (in either manual or automatic installation mode), it stops the learning process and prompts you for confirmation that you want to stop learning and install the learned limits. Once you have confirmed, the learned limits are automatically installed or prepared for manual installation.

Parameter	Value/Range	Description
Install mode	Automatic, Manual	<ul style="list-style-type: none"> • Automatic: the learned values are automatically applied. • Manual: the learned values are stored for you to review and enter.
Duration	1-365	Days for maximum learning duration.

Configuring digital input alarms using ION Setup

You can use ION Setup to configure the digital alarm settings.

1. Start ION Setup.
2. Open the Setup Assistant for your meter.
3. Navigate to **Alarming > Digital Input**.
4. Configure the digital input alarm settings by selecting an input and clicking **Edit**. Some settings are not configurable and are grayed out.
5. Click **Save** to save the changes to the meter.

Parameter	Value/Range	Description
Input	Input On/Input Off	Specifies the input state/alarm behavior: <ul style="list-style-type: none"> • Input On: the alarm is on when the digital input is on. • Input Off: the alarm is on when the digital input is off.
Force Off	Checked/Unchecked	Forcing the alarm off disables all functions of the associated input. To stop an alarm from being displayed without affecting digital input features, set the alarm priority to Info only.
Label	String value	When available, lets you modify the default label so it more clearly identifies the alarm. Letters, numbers, and underscores are permitted. Spaces are not permitted.
Alarm Priority	None, Info only, Low, Medium or High	Specifies the priority level of the digital input alarm. To disable the alarm, set priority to Info only.
Custom Priority	0-255	Select custom priority to view and configure the event priority of the event associated with the alarm. The event log cutoff value is displayed for reference; event priorities above the cutoff are stored in the meter's event log.

Alerting

An alert is an external notification produced by the meter to indicate changes, for example, a change of state for a digital input, or a power quality event such as a sag or swell.

Alerts are generated when a pulse or trigger that is configured to indicate the alert condition activates. You can configure alerts to send notification emails or messages to your energy management system through your meter's existing Ethernet communications connections. You can configure alert messages as a simple text string or you can also include device information. You can configure the alert's priority so that alerts are also recorded in the meter's event log.

You can configure multiple alerts on a single meter, each having different activation triggers, messages and/or transmission types. For instance, you can have two alerts, one generating an email, the other sending a message to your energy management system, but using the same trigger conditions; or you can have two alerts with different conditions that send two unique emails to two different email addresses. You can also generate alerts based on triggers from devices connected to your meter.

Creating alerts is an advanced feature that requires familiarity with ION architecture and your power system and communications network. To create an alert, you must configure the Alert module using a configuration tool. You must also configure your device's communications as needed to send the alerts, such as configuring your meter's SMTP settings and connecting it via Ethernet to an SMTP mail server in order to send an alert by email.

Go to www.schneider-electric.com to see the *ION meter alerts* technical note for detailed information on creating and configuring alerts, and the *ION Reference* for detailed information about the Alert module and its operation.

Resets

Meter resets

Resets allow you to clear various accumulated parameters stored on your meter or reinitialize the meter or meter accessories.

Meter resets clear your meter's onboard data logs and other related information. Resets are typically performed after you make changes to the meter's basic setup parameters (such as frequency, VT/PT or CT settings) to clear invalid or obsolete data in preparation for putting the meter into active service.

Option module reset

Perform an option module reset if your option modules are not communicating to your meter.

During an option module reset, your option module may not operate normally, and digital and analog outputs may change state.

⚠ WARNING

UNINTENDED OPERATION

Do not use the meter for critical control or protection applications where human or equipment safety relies on the operation of the control circuit.

Failure to follow these instructions can result in death, serious injury, or equipment damage.

You can reset your meter's option module bus through the display or using ION Setup. This power cycles all the modules attached to your meter. If you have queued firmware updates for your option modules on your meter's internal FTP site, the firmware updates are performed. Your option modules do not operate normally during an option module reset.

By default, your meter is configured so that your meter automatically performs an option bus reset when needed to help keep the option modules operating normally. Contact Technical Support for instructions on changing this default configuration.

Available resets

You can perform various meter resets through the meter's display or ION Setup.

Reset	Description
Master Reset	<ul style="list-style-type: none"> Clears all the cumulative and derived quantities from the meter (including demand, peak demand, energy and revenue parameters). Clears meter event and waveform logs. Clears COMTRADE waveform records from the meter's internal FTP server. Clears the meter's data logs.
Peak Demand Reset	<p>Clears the peak demand values logged in the meter.</p> <p>NOTE: The peak demand reset has a lockout period that sets the minimum time allowed between consecutive resets.</p>
Min/Max Reset	Clears all accumulated maximum and minimum values stored in the meter.
Digital Input Count Reset	Clears the digital input status change counters.
Harmonics Min/Max Reset	Clears all accumulated maximum and minimum harmonics values stored in the meter.
Disturbance Count Reset	Clears the sag/swell event counter. The sag/swell event counter counts the number of sag/swells that have occurred since power-up or the last reset, to provide power quality information to energy management systems.

Reset	Description
EN50160 Reset	Clears all EN50160 parameters and statistics accumulated in the meter.
Option modules reset	Resets communications to the meter's expansion modules.
Conditional energy reset	Clears the conditional energy values stored in the meter.
Input metering reset	Clears the input metering values stored in the meter.

Related Topics

- Peak demand

Performing meter resets using the display

You can perform meter resets from the display after entering a valid password.

Revenue-locked meters must be unlocked to perform resets that impact revenue data.

Your meter's digital and analog outputs may change state or may not function during resets.

⚠ WARNING

HAZARD OF UNINTENDED OPERATION

Do not use the meter for critical control or protection applications where human or equipment safety relies on the operation of the control circuit.

Failure to follow these instructions can result in death, serious injury, or equipment damage.

Meter resets clear the meter's onboard data logs and other related information.

NOTICE

DATA LOSS

Ensure all important data from the device has been retrieved before performing a reset.

Failure to follow these instructions can result in data loss.

1. Navigate to **Setup Menu > Resets**.
2. Press the edit button to access the configuration menu and use the up and down buttons to navigate through and select the resets you want to perform. Press the select button to perform the resets.

Related Topics

- Revenue locking

Resets

You can perform meter resets using the display.

Parameter	Description
Master Reset	<ul style="list-style-type: none"> Clears all the cumulative and derived quantities from the meter (including demand, peak demand, energy, revenue and test mode parameters) Clears meter event and waveform logs Clears COMTRADE waveform records from the meter's internal FTP server Clears the meter's data logs
Peak Demand Reset	Clears the peak demand values logged in the meter
Min/Max Reset	Clears all accumulated maximum and minimum values stored in the meter
Digital Input Count Reset	Clears the digital input state change counters
Harmonics Min/Max Reset	Clears all accumulated maximum and minimum harmonics values stored in the meter
Disturbance Count Reset	Clears the sag/swell event counter
EN50160 Reset	Clears all EN50160 parameters and statistics accumulated in the meter
Option Modules Reset	Restarts all option modules attached to the meter

Performing meter resets using ION Setup

You can perform meter resets on your meter using ION Setup.

Revenue-locked meters must be unlocked to perform resets that impact revenue data.

Meter resets clear the meter's onboard data logs and other related information.

NOTICE
<p>DATA LOSS</p> <p>Ensure all important data from the device has been retrieved before performing a reset.</p> <p>Failure to follow these instructions can result in data loss.</p>

1. Open the Setup Assistant for your meter.
2. Select the **Verification** screen.
3. Select **Normal Mode** and click **Display**.
4. Select the desired tab in the **Normal Mode** dialog box. Depending on the tab selected, different resets are available.

Tab	Reset available
Energy	Master Reset
Rolling Demand	Peak Reset Master Reset
Volts, Amps and Power	Master Reset
Conditional Energy	Cnd Reset Master Reset
Input Metering	IM(n) Reset NOTE: n is the input metering number, for example IM1. Peak Reset Master Reset

5. Click the appropriate button to perform the reset.

For some resets, the meter indicates that the reset is in progress. Do not configure or power down your meter until it indicates that the reset is complete or some parameters may not be completely reset.

Related Topics

- Revenue locking

Measurements

Power and power factor

The sampled measurements taken at the meter's voltage and current inputs provide data for calculating power and power factor.

In a balanced 3-phase alternating current (AC) power system source, the AC voltage waveforms on the current-carrying conductors are equal but offset by one-third of a period (a phase angle shift of 120 degrees between the three voltage waveforms).

Power factor (PF)

Power factor (PF) is the ratio of real power (P) to apparent power (S).

Power factor is provided as a number between -1 and 1 or as a percentage from -100% to 100%, where the sign is determined by the convention.

$$PF = \frac{P}{S}$$

An ideal, purely resistive load has no reactive components, so its power factor is one (PF = 1, or unity power factor). Inductive or capacitive loads introduce a reactive power (Q) component to the circuit which causes the PF to become closer to zero.

True PF and displacement PF

The meter supports true power factor and displacement power factor values:

- True power factor includes harmonic content.
- Displacement power factor only considers the fundamental frequency.

NOTE: Unless specified, the power factor displayed by the meter is true power factor.

Apparent, active and reactive power (PQS)

Apparent power (S) is the capacity of your measured power system to provide active (real power, P) and reactive power (Q).

A typical AC electrical system load has both resistive and reactive (inductive or capacitive) components. Resistive loads consume real power (P). Reactive power (Q) is either consumed (inductive loads) or generated (capacitive loads).

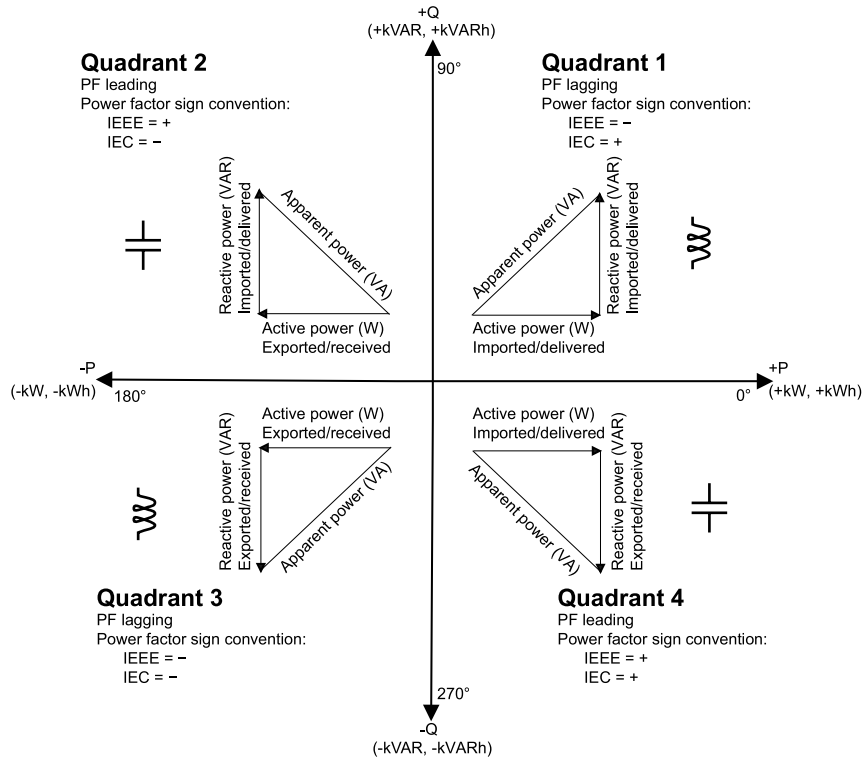

The units for power are watts (W or kW) for real power P, vars (VAR or kVAR) for reactive power Q, and volt-amps (VA or kVA) for apparent power S.

Positive real power P(+) flows from source to load, and negative real power P(-) flows from the load to the power source.

Current phase shift from voltage

Electrical current can lag, lead, or be in phase with the AC voltage waveform, and is typically associated with the type of load — inductive, capacitive or resistive.

For purely resistive loads, the current waveform is in phase with the voltage waveform. For capacitive loads, current leads voltage. For inductive loads, current lags voltage.

The following diagrams show how voltage and current waveforms shift based on load type under ideal (laboratory) conditions.

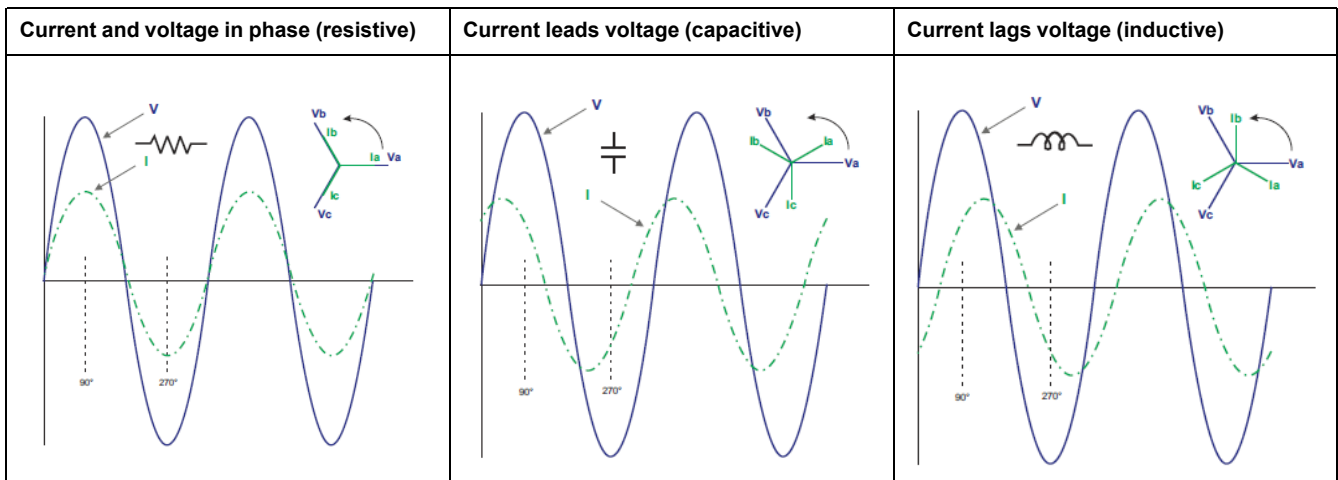

Power demand

Power demand is a measure of average power consumption over a fixed time interval.

NOTE: If not specified, references to “demand” are assumed to mean “power demand.”

The meter measures instantaneous consumption and can calculate demand using various methods.

Peak demand

Peak (or maximum) demand is the highest demand level recorded over the billing period.

Power utilities generally bill commercial customers based on their peak usage levels, called peak demand (in kW) and energy consumption (in kWh). Peak (or maximum) demand is the highest demand level recorded over the billing period. You can view peak demand values on your meter’s display.

Your meter calculates the average current demand and kW, kVAR and kVA demand using sliding window demand methods. The meter supports coincident demand values when a peak demand is detected.

Your meter’s default configuration is suitable for most applications, or you can customize it for your specific application. You can configure the minimum time between consecutive demand resets.

NOTE: If not specified, references to “demand” are assumed to mean “power demand”.

Peak demand reset lockout

The demand reset lockout time sets the minimum time allowed between consecutive demand resets; the meter ignores any attempts to reset demand that occur within the lockout period.

The peak demand reset lockout period is user-configurable, with a default value of 25 days.

See the ION Setup online help for instructions on how to configure demand peak and the demand reset lockout period on your meter.

See the ION Reference, available from www.schneider-electric.com, for detailed information on how Sliding Window Demand modules measure and calculate demand values.

Related Topics

- Meter resets
- Data viewing using your meter’s display

Sliding window demand

To calculate demand values, your meter uses the sliding window averaging (or rolling interval) method which divides the demand interval into a set number of subintervals of specified duration.

The demand is measured electronically based on the average load level over the most recent set of subintervals. Sliding window demand also provides predicted demand values.

Examples of sliding window demand

This example shows two different ways of configuring a 15-minute demand interval:

- Single interval (also called block or timed block): the 15-minute demand interval is defined as a single subinterval with a duration of 15 minutes.
- Sliding window (also called rolling block): the 15-minute demand interval is defined as three subintervals with a duration of 5 minutes each. This method offers better response time than a single interval.

Single interval (block)

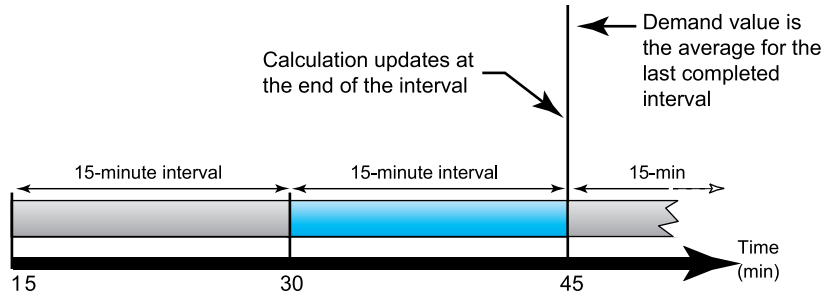

Sliding window (rolling block)

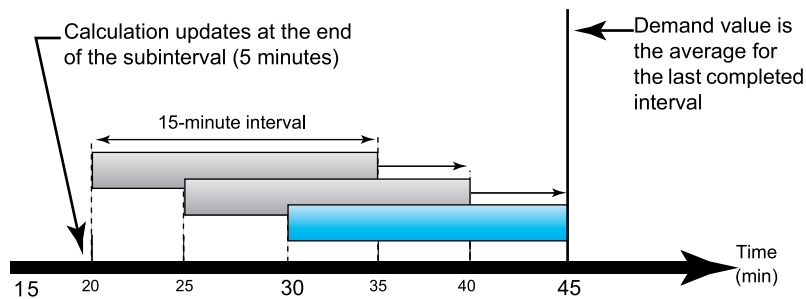

WAGES monitoring

WAGES monitoring allows you to record and analyze all energy sources and utilities usage.

Your energy system may use several different types of energy. For example, you may consume steam or compressed air for industrial processes, electricity for lights and computers, water for cooling and natural gas for heating. WAGES monitoring collects the usage information from all these different energy sources to enable a more complete energy analysis.

WAGES information can help you:

- Identify losses or inefficiencies.
- Modify demand to reduce costs.
- Optimize energy source usage.

WAGES example

This example shows WAGES monitoring for a water flow meter.

You can connect your meter's digital input to a transducer that sends a pulse for every 15 kiloliters (4000 US Gal) of water. After configuring an input metering channel and assigning it to the digital input, the meter is able to detect and record the incoming pulses. An energy management system can then use the information from the meter to perform WAGES analysis.

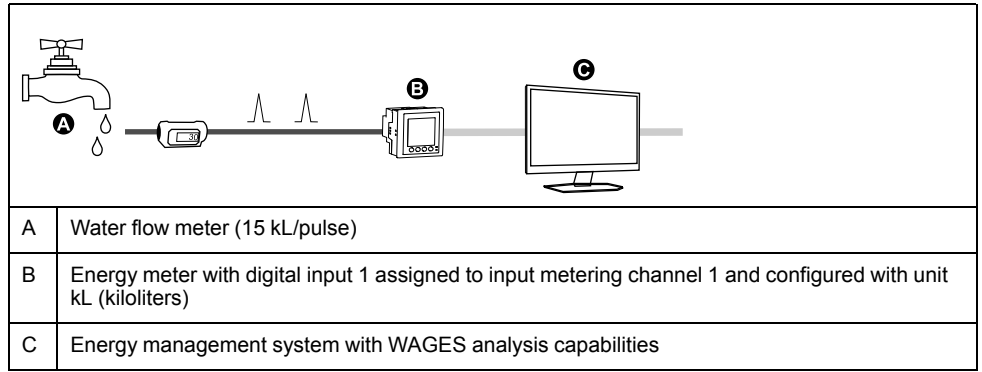

Incremental energy

Incremental energy allows you to define a start time, end time, and the time interval (increments) for incremental energy accumulation.

At the end of each interval, the energy accumulated during that period is stored. By default, the meter only records the previous interval's incremental energy and the instantaneous energy accumulations in the active interval.

The first interval of incremental energy accumulation begins at the specified start time. Incremental energy ends at the specified end time, which may result in a truncated interval if the interval duration does not divide evenly into the overall incremental energy duration (for example, an interval duration of three hours with an overall duration of five hours truncates the last interval duration to two hours). The latest value for the specified end time is midnight (24:00).

Your start time must be before the end time and after midnight, and the period over which incremental energy is accumulated cannot include midnight. This is because your meter's start and end times are defined relative to midnight.

Start: 6 am, End: 12 am, interval: 3 hrs	Incremental energy accumulates from 6 am to midnight in intervals of 3 hours.
Start: 6 am, End: 2 am, interval: 3 hrs	Incremental energy will not function. End time must be after start time and before or equal to midnight.

Incremental energy helps provide information for analyzing energy and power usage against present or future utility rates, and is useful for comparing different time-of-use rate structures.

When configuring incremental energy, shorter incremental energy periods provide more granular data which can make the data easier to use for comparison purposes.

Incremental energy example

- Start time: 8 am or 08:00
- End time: 12 am or 24:00
- Interval: 420 minutes (7 hours)

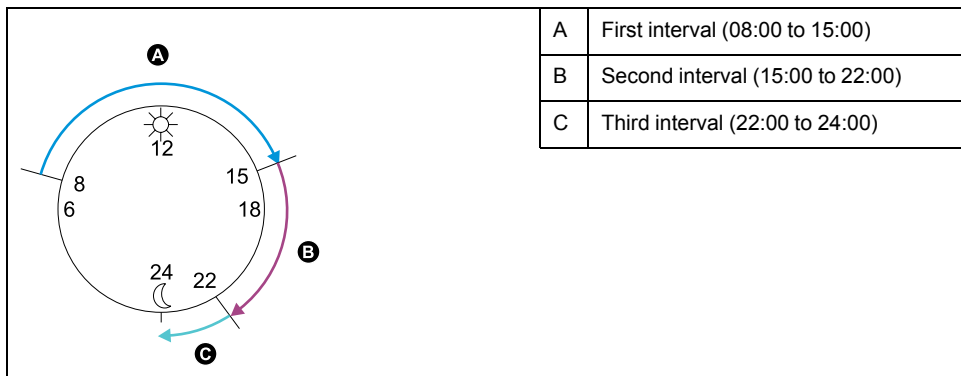

The first incremental energy interval is from 8 am (start time) to 3 pm, and is seven hours long. The second incremental energy interval is from 3 pm to 10 pm, and is also seven hours long. The third interval is from 10 pm to 12 am, and is only 2 hours long because 12 am is the specified end time. These intervals repeat every 24 hours until the configuration is changed or incremental energy feature is disabled.

Configuring incremental energy using ION Setup

You can configure incremental energy using ION Setup.

1. Start ION Setup.
2. Open the Setup Assistant for your meter.
3. Navigate to **Energy Applications > Incremental Energy**.
4. Select **Status** and click **Edit**. The incremental energy configuration screen is displayed.

NOTE: To display parameters for configuration, select **Enable**.

5. Select the parameter to configure and click **Edit**. Your changes are made to the meter.

NOTE: Configuring any parameter resets the incremental energy values recorded by your meter.

Parameter	Range	Description
Status	Enable/disable	Enables the incremental energy feature.
Start time	12:00 am to 11:59 pm	The incremental energy first interval's start time. The start time must be prior to the end time for energy accumulation.
End time	12:01 am to 12:00 am	The end time for incremental energy. The end time must be after the start time and be less than or equal to 12 am (midnight).
Interval duration	Configurable	The increment period for the incremental energy duration.

Conditional energy

Conditional energy allows you to define an accumulation period for real and reactive energy using one of your meter's digital inputs.

You can use conditional energy to track four-quadrant accumulated energy during a specific period; for example you may want to track accumulated energy values during a particular process controlled using a programmable logic controller (PLC).

Conditional energy is accumulated until it is reset. The conditional energy reset date and time information is stored in the meter's event log.

Related Topics

- Apparent, active and reactive power (PQS)

Configuring conditional energy using ION Setup

You can enable and configure conditional energy settings using ION Setup.

When configuring your meter, the configuration interface may show all of the possible ports, regardless of what is physically available on your meter.

One of your device's digital inputs must be connected and configured to define when conditional energy is accumulated.

1. Start ION Setup.
2. Open the Setup Assistant for your meter.
3. Navigate to **Energy Applications > Digital Input Based**. Review the digital inputs assigned to applications to help ensure there are no conflicting usages.
4. Select **Conditional Energy** and click **Edit**. The **Conditional Energy Setup** screen is displayed.
5. Select **Enabled** to enable the conditional energy feature.
6. Click **Select** to define the digital input. The input's state determines whether conditional energy is accumulated. When this digital input is on, conditional energy is accumulated.

NOTE: It is recommended to set **Assigned Input** to No Connection to disable the conditional energy feature by removing any port associations.

7. Click **OK** to save your configuration.

Trending and forecasting overview

Trending and forecasting is a feature on your device that predicts the next set of measured or calculated data by plotting and analyzing trends in historical data.

Trending and forecasting data is a useful tool to help analyze changes in load and power quality and forecasting values such as demand. For your meter's trending and forecasting feature to work, you only need to give the meter time to accumulate data.

Trending and forecasting implementation

Data used for trending and forecasting can be logged for specific intervals.

Data used is logged for the following intervals:

- Every hour for the last 24 hours
- Every day for the last month
- Every week for the last 8 weeks
- Every month for the last 12 months

The following parameters are configured for trending and forecasting using ION Setup:

kW sd del-rec (demand)	Freq (frequency)
VII ab	I a mean
VII bc	I b mean
VII ca	I c mean
VII avg	I avg mean

You can configure the start day of the week for trending and forecasting using ION Setup.

Viewing trending and forecasting data on your meter's webpages

You can select data for forecasting and trending and view the resulting information using your meter's webpages.

For trending and forecasting to operate, your meter must have accumulated data for at least two of the specified intervals; for example, if you want to view a daily graph, your meter must have accumulated data for at least two previous days before the present day.

1. Log in to your meter's webpages
2. Click **Monitoring > Trending & Forecasting**
3. Select the **Target** and **Interval**. The graph for the selected data is displayed.

Power quality

Power quality overview

Your meter measures voltage and current harmonics, and calculates several harmonic distortion values as well as K-factor and crest factor values.

You must configure your meter with nominal values for voltage, current and frequency for the power system being monitored in order for the meter to perform power quality calculations. Your meter also creates a phasor diagram, including numeric values for magnitude and angle, to represent your power system.

Sag/swell overview

Your meter monitors your power system's voltage and current for sags and swells (INCITS (CBEMA) Type 2 and Type 3 disturbances); it then reports the disturbance's magnitude and duration.

You can manually enter the limits (criteria) used by the meter to identify a sag or swell, or you can have your meter learn sag/swell limits by monitoring your power system.

Related Topics

- [Waveform recording overview](#)
- [Configuring waveform recording using ION Setup](#)
- [Implementing sag/swell limit learning using ION Setup](#)

Harmonics overview

Harmonics information is valuable for power quality analysis, determining properly rated transformers, maintenance and troubleshooting.

Harmonics are integer multiples of the fundamental frequency of the power system. Harmonics information is required for compliance to system power quality standards such as EN50160 and meter power quality standards such as IEC 61000-4-30.

Harmonics measurements include per-phase magnitudes and angles (relative to the fundamental frequency of the phase A voltage) for the fundamental and higher harmonics relative to the fundamental frequency. The meter's power system setting defines which phases are present and determines how line-to-line or line-to-neutral voltage harmonics and current harmonics are calculated.

Harmonics are used to identify whether the supplied system power meets required power quality standards, or if non-linear loads are affecting your power system. Power system harmonics can cause current flow on the neutral conductor, and damage to equipment such as increased heating in electric motors. Power conditioners or harmonic filters can be used to minimize unwanted harmonics.

Viewing harmonics information using the display

You can view detailed harmonics data through your meter's display.

1. With your meter in alt mode, navigate to **Power Quality > Harmonics**. The total harmonic distortion (THD) screens are displayed.
2. Press the more button, and select the desired harmonics. The per-phase harmonics are graphically displayed.

- 3. Press the left and right buttons to move to individual harmonics. The harmonic number, magnitude and angle are displayed.

Related Topics

- Data viewing using your meter's display

Voltage crest factor

Crest factor is the ratio of peak to RMS voltage values.

For a pure sinusoidal waveform, crest factor is equal to 1.414. The meter uses the following equation to calculate crest factor:

$C = \frac{V_{peak}}{V_{RMS}}$	C = Crest factor
	V_{peak} = Voltage peak
	V_{RMS} = Voltage RMS

Crest factor current

Crest factor is the ratio of peak to RMS current values.

For a pure sinusoidal waveform, crest factor is equal to 1.414. The meter uses the following equation to calculate crest factor:

$Crest\ factor = \frac{I_{peak}}{I_{RMS}}$	C = Crest factor
	I_{peak} = Current peak
	I_{RMS} = Current RMS

K-factor

K-factor relates the heating effect of a distorted current in a transformer to a sinusoidal current with the same RMS magnitude — it describes a transformer’s ability to serve non-linear loads without exceeding rated temperature rise limits.

The K-factor is equal to the sum of the squares of the harmonic currents multiplied by the squares of the harmonic order. The meter uses the following equation to calculate K-factor:

$$K = \frac{\sum_{n=1}^h (I_n^2 \times h^2)}{\sum_{n=1}^h I_n^2}$$

Where K is the K-factor, h is the harmonic order and I_h is the true RMS current of harmonic order h.

Harmonic content calculations

Harmonic content (H_C) is equal to the RMS value of all the non-fundamental harmonic components in one phase of the power system.

The meter uses the following equation to calculate H_C :

$$HC = \sqrt{(H_2)^2 + (H_3)^2 + (H_4)^2 \dots}$$

TDD calculations

TDD (total demand distortion) evaluates the harmonic currents between an end user and a power source.

The harmonic values are based on a point of common coupling (PCC), which is a common point where each user receives power from the power source.

The meter uses the following equation to calculate TDD:

$$TDD = (\sqrt{(HCIA)^2 + (HCIB)^2 + (HCIC)^2}) / (I_{Load}) \times 100$$

Where I_{Load} is equal to the maximum demand load on the power system.

thd and TDD

Your meter can be configured to provide thd (total harmonic distortion using the total RMS value for the content rather than the fundamental content) and TDD (total demand distortion, the harmonic current distortion against the maximum demand of the electrical system).

$$thd = H_C / RMS * 100\%$$

$$TDD = H_C / Demand_{Max} * 100\%$$

This is an advanced procedure that should only be performed by users with an advanced knowledge of power quality, ION architecture, and the power system being monitored.

See the ION Reference, available from www.schneider-electric.com, for details about the Harmonics Measurement module.

Phasors

Phasors are used to represent the voltage and current relative magnitude and angles.

The length of the lines in the phasor diagram represent the relative magnitude of the voltages with respect to the other phase voltages, and the currents with respect to the other phase currents. All angles are measured with respect to the Va/V1 phase. The Va/V1 phasor is fixed to the right-hand horizontal axis (positive x-axis). Positive angles are measured counterclockwise.

Numeric values are provided for the magnitude and relative angle for each voltage and current phase.

Phasor information can be used to troubleshoot incorrect connections on the meter's voltage and current inputs (for example, switched phase wiring or polarity errors), if you know how the phasors should be oriented for your power system.

Disturbance direction detection overview

Your meter has disturbance direction detection capabilities to help you determine the location of a power system disturbance.

When a disturbance occurs, the meter analyzes the disturbance information to determine the direction of the disturbance relative to the meter. This analysis includes a confidence level indicating the level of certainty that the disturbance is in the determined direction, and is stored in your meter's event log.

Disturbance direction detection is enabled on your meter by default and does not require any additional configuration beyond setting the nominal voltage and nominal frequency.

Disturbance direction detection can help locate the source of a disturbance when used in a system of disturbance direction detection devices, as shown in the diagram below.

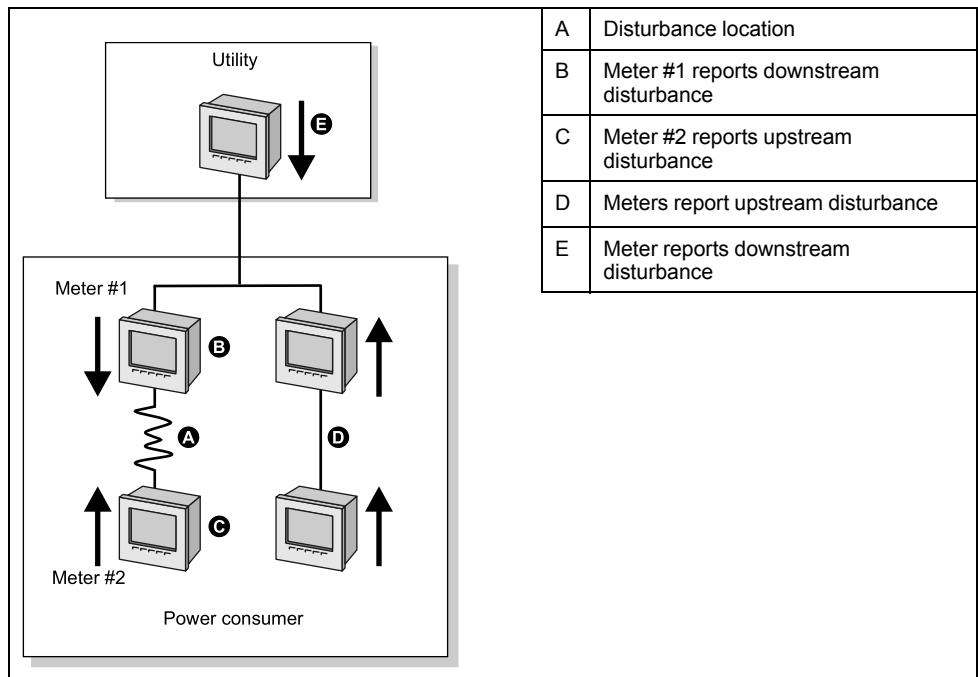

The arrows show the direction the meters have determined for the disturbance. With this information, you can determine that the disturbance occurred between meter #1 and meter #2, and can focus on that section of your system to find the cause of the disturbance.

Disturbance direction detection events information

The results of the disturbance direction detection algorithm appear in the meter's event log.

The image below shows an example of how the Disturbance Direction Detection event appears in your meter's event log when viewed using ION Setup.

NOTE: You can view your meter's event log through the display and ION Setup.

Date/Time	Cause	Value	Effect	Value
10/22/2007 2:29:11.918 PM	Sag/Swell 1	Disturbance End	SS1 DistState	Normal
10/22/2007 2:29:10.702 PM	Dist Direction Detection 1	DDD Analysis Done	Dist Direction Detection 1	Disturbance Direction Detected - Upstream - High Confidence
10/22/2007 2:29:10.702 PM	Sag/Swell 1	Disturbance Start	SS1 DistState	Disturbance

See the ION Reference, available from www.schneider-electric.com, for more detailed information about the Disturbance Direction Detection module.

Related Topics

- Event log overview

Verifying accuracy

Overview of meter accuracy

All meters are tested and verified at the factory in accordance with International Electrotechnical Commission (IEC) and American National Standards Institute (ANSI) standards.

Your digital power meter typically does not require re-calibration. However, in some installations a final accuracy verification of the meters is required, especially if the meters will be used for revenue or billing applications.

Accuracy test requirements

The most common method for testing meter accuracy is to apply test voltages and currents from a stable power source and compare the meter's readings with readings from a reference device or energy standard.

Signal and power source

The meter maintains its accuracy during voltage and current signal source variations but its energy pulsing output needs a stable test signal to help produce accurate test pulses. The meter's energy pulsing mechanism needs approximately 10 seconds to stabilize after every source adjustment.

The meter must be connected to control power in order to conduct accuracy verification testing. Refer to your meter's installation documentation for power supply specifications.

⚠ DANGER

HAZARD OF ELECTRIC SHOCK, EXPLOSION, OR ARC FLASH

Verify the device's power source meets the specifications for your device's power supply.

Failure to follow these instructions will result in death or serious injury.

Control equipment

Control equipment is required for counting and timing the pulse outputs from an energy pulsing LED or digital output.

- Most standard test benches have an arm equipped with optical sensors to detect LED pulses (the photodiode circuitry converts detected light into a voltage signal).
- The reference device or energy standard typically has digital inputs that can detect and count pulses coming from an external source (i.e., the meter's digital output).

NOTE: The optical sensors on the test bench can be disrupted by strong sources of ambient light (such as camera flashes, florescent tubes, sunlight reflections, floodlights, etc.). This can cause test errors. Use a hood, if necessary, to block out ambient light.

Environment

The meter should be tested at the same temperature as the testing equipment. The ideal temperature is about 23 °C (73 °F). Make sure the meter is warmed up sufficiently before testing.

A warm-up time of 30 minutes is recommended before beginning energy accuracy verification testing. At the factory, the meters are warmed up to their typical operating temperature before calibration to help ensure that the meters will reach their optimal accuracy at operating temperature.

Most high precision electronic equipment requires a warm up time before it reaches its specified performance levels. Energy meter standards allow the manufacturers to specify meter accuracy derating due to ambient temperature changes and self-heating.

Your meter complies with and meets the requirements of these energy metering standards.

For a list of accuracy standards that your meter complies to, contact your local Schneider Electric representative or download the meter brochure from www.schneider-electric.com.

Reference device or energy standard

To help ensure the accuracy of the test, it is recommended that you use a reference device or reference energy standard with a specified accuracy that is 6 to 10 times more accurate than the meter under test. Before you start testing, the reference device or energy standard should be warmed up as recommended by its manufacturer.

NOTE: Verify the accuracy and precision of all measurement equipment used in accuracy testing (for example, voltmeters, ammeters, power factor meters).

Energy pulsing

Your meter has energy pulsing LEDs and a digital output that can be used for energy pulsing.

Your meter has energy pulsing LEDs, one visible light and one infrared. These LEDs emit pulses that are then used to determine the accuracy of the meter's energy measurements. The pulses of light indicate accumulated energy; the meter's accumulations are compared with the reference/standard's accumulated energy in order to help determine the meter's accuracy.

Your meter also has a digital output that can be used for energy pulsing. The relay closes (low impedance) and then opens (high impedance) to represent a pulse. If the accuracy testing equipment has a voltage requirement, a current-limited wetting supply voltage must be provided.

NOTE: Digital outputs on option modules should not be used meter accuracy testing.

Related Topics

- LED locations

Verifying accuracy test meter settings

Your meter's power system and other parameters must be configured for accuracy testing.

Meter parameter	Value
Volts mode	4W-Wye (4 wire Wye)
PT/CT correction	Disabled
Test mode	Active NOTE: In test mode, your meter's billing quantities stop accumulating, and the data is sent to special test mode registers. These registers are cleared when you exit test mode.

Verifying accuracy test

The following tests are guidelines for accuracy testing your meter; your meter shop may have specific testing methods.

⚠ DANGER

HAZARD OF ELECTRIC SHOCK, EXPLOSION, OR ARC FLASH

- Apply appropriate personal protective equipment (PPE) and follow safe electrical work practices. See NFPA 70E in the USA, CSA Z462 or applicable local standards.
- Turn off all power supplying this device and the equipment in which it is installed before working on the device or equipment.
- Always use a properly rated voltage sensing device to confirm that all power is off.
- Do not exceed the device's ratings for maximum limits.
- Verify the device's power source meets the specifications for your device's power supply.

Failure to follow these instructions will result in death or serious injury.

1. Turn off all power supplying this device and the equipment in which it is installed before working on the device or equipment.
2. Use a properly rated voltage sensing device to confirm that all power is off.
3. Connect the test voltage and current source to the reference device or energy standard. Ensure all voltage inputs to the meter under test are connected in parallel and all current inputs are connected in series.

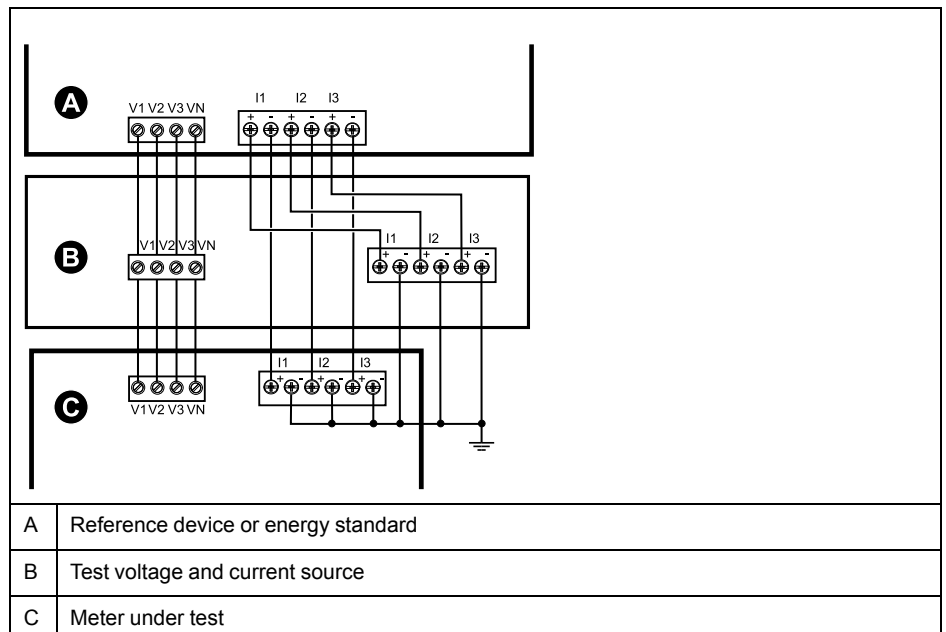

4. Connect the control equipment used for counting the standard output pulses using one of these methods:

Option	Description
Energy pulsing LED	Align the red light sensor on the standard test bench armature over the energy pulsing LED.
Digital output	Connect the meter's digital output to the standard test bench pulse counting connections.

NOTE: When selecting which method to use, be aware that energy pulsing LEDs and digital outputs have different pulse rate limits.

5. Before performing the verification test, let the test equipment power up the meter and apply voltage for at least 30 seconds. This helps stabilize the internal circuitry of the meter.
6. Configure the meter’s parameters for verifying accuracy testing.
7. Depending on the method selected for counting the energy pulses, configure the meter’s energy pulsing LED or one of the digital outputs to perform energy pulsing. Set the meter’s energy pulse constant so it is in sync with the reference test equipment.
8. Perform accuracy verification on the test points. Run each test point for at least 30 seconds to allow the test bench equipment to read an adequate number of pulses. Allow 10 seconds of dwell time between test points.

Calculate the number of required pulses

The reference test equipment typically requires you to specify the number of pulses required for a test duration of “t” seconds.

Normally, the number of pulses required is at least 25 pulses, and the test duration is greater than 30 seconds.

Use the following formula to calculate the required number of pulses:

$\text{Number of pulses} = \frac{N_e * V * I * PF * t}{3600 * K_t}$	
Ne	Number of metering elements used
V	Test point voltage in line-to-neutral volts (V) per phase
I	Test point current in amps (A) per phase
t	Test duration in seconds (s) which must be longer than 30 seconds
PF	Power factor
Kt	Pulse constant programmed in the meter under test in Wh/pulse

Round up the result of the calculation to the nearest integer number of pulses.

Calculation for number of required pulses

This example calculates the number of pulses required for an inductive load 3-phase test point with a test duration of 60s; the source is configured to use V = 120V, I = 5A, PF = -0.5; the pulse constant of the meter under test is Kt = 1.8 Wh/pulse.

$$8.3 = \frac{3 * 120 \text{ V} * 5 \text{ A} * .5 * 60 \text{ s}}{3600 * 1.8}$$

Round the number up to the nearest integer: Number of pulses = 9

Percentage error calculation for accuracy verification testing

Accuracy verification testing requires you to calculate the percentage error between the meter being tested and the reference/standard.

Calculate the percentage error for every test point using the following formula:

$$\text{Energy error} = (EM - ES) / ES * 100\%$$

Where:

- EM = energy measured by the meter under test
- ES = energy measured by the reference device or energy standard.

NOTE: If accuracy verification reveals inaccuracies in your meter, they may be caused by typical sources of test errors. If there are no sources of test errors present, please contact your local Schneider Electric representative.

Typical sources of test errors

If you see excessive errors during accuracy testing, examine your test setup and test procedures to eliminate typical sources of measurement errors.

Typical sources of accuracy verification testing errors include:

- Loose connections of voltage or current circuits, often caused by worn-out contacts or terminals. Inspect terminals of test equipment, cables, test harness and the meter under test.
- Meter ambient temperature is significantly different than 23 °C (73 °F).
- Floating (ungrounded) neutral voltage terminal in any configuration with unbalanced phase voltages.
- Inadequate meter control power, resulting in the meter resetting during the test procedure.
- Ambient light interference or sensitivity issues with the optical sensor.
- Unstable power source causing energy pulsing fluctuations.
- Incorrect test setup: not all phases connected to the reference device or the energy standard. All phases connected to the meter under test should also be connected to the reference meter/standard.
- Moisture (condensing humidity), debris or pollution present in the meter under test.

Accuracy verification test points

The meter should be tested at full and light loads and at lagging (inductive) power factors to help ensure testing over the entire range of the meter.

The test amperage and voltage input rating are labeled on the meter. Refer to the installation sheet or data sheet for your meter’s nominal current, voltage and frequency specifications.

Watt-hour test point	Sample accuracy verification test point
Full load	100% to 200% of the nominal current, 100% of the nominal voltage and nominal frequency at unity power factor or one (1).
Light load	10% of the nominal current, 100% of the nominal voltage and nominal frequency at unity power factor or one (1).
Inductive load (lagging power factor)	100% of the nominal current, 100% of the nominal voltage and nominal frequency at 0.50 lagging power factor (current lagging voltage by 60° phase angle).

VAR-hour test point	Sample accuracy verification test point
Full load	100% to 200% of the nominal current, 100% of the nominal voltage and nominal frequency at zero power factor (current lagging voltage by 90° phase angle).
Light load	10% of the nominal current, 100% of the nominal voltage and nominal frequency at zero power factor (current lagging voltage by 90° phase angle).
Inductive load (lagging power factor)	100% of the nominal current, 100% of the nominal voltage and nominal frequency at 0.87 lagging power factor (current lagging voltage by 30° phase angle).

Revenue

Revenue locking

Revenue locking your meter helps prevent modifications to revenue-related settings and data on your meter, or tampering with your meter’s voltage and current connections.

Revenue locking may be required to help meet government regulations and utility security requirements, or can be used to help ensure the validity of revenue data.

Download the ION Device Template Reference, available from www.schneider-electric.com to view a complete listing of revenue-locked parameters and data.

See the meter’s catalog pages, available from www.schneider-electric.com, or consult your local Schneider Electric representative for information about your device, its options and accessories.

Related Topics

- Revenue lock LED behavior

Revenue lock switch

You can revenue lock your meter using the revenue lock switch located on the meter base.

This switch is accessed through a sealable cover.

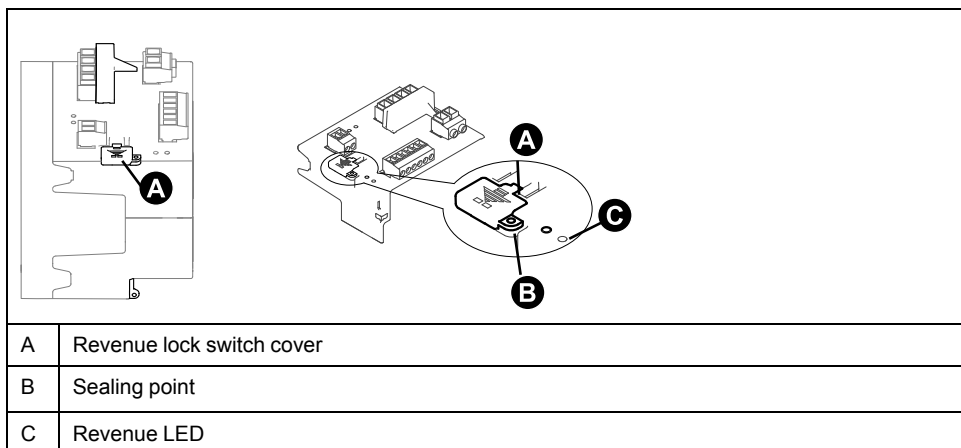

Revenue locking your meter

You can lock and unlock your meter using the revenue lock switch located on the meter base.

⚠ DANGER

HAZARD OF ELECTRIC SHOCK, EXPLOSION OR ARC FLASH

- Apply appropriate personal protective equipment (PPE) and follow safe electrical work practices. See NFPA 70E in the USA, CSA Z462 or applicable local standards.
- Turn off all power supplying this device and the equipment in which it is installed before working on the device or equipment.
- Always use a properly rated voltage sensing device to confirm that all power is off.

Failure to follow these instructions will result in death or serious injury.

1. Turn off all power supplying this device and the equipment in which it is installed before working on the device or equipment.
2. Always use a properly rated voltage sensing device to confirm that all power is off.
3. Open the revenue lock switch cover.
4. Locate the revenue lock switch.
5. Toggle revenue lock switch on or off.
6. Close the revenue lock switch cover and make sure it is firmly in place.
7. Seal the revenue lock switch cover if required.

PT/CT correction

PT/CT correction, also called instrument transformer correction, can help reduce the need to replace transformers in installations where high accuracy is required.

The primary application for PT/CT (potential transformer / current transformer) correction is to apply correction factors for ratio errors and phase angle errors to instrument transformers. PT/CT correction is done for each current and voltage input to the meter and only affects 1-second power meter data and values derived from it, such as energy or demand. No high-speed, harmonics or waveform values are affected by the correction.

NOTE: For those familiar with ION architecture, the relevant 1-second Power Meter module outputs are compensated using the Instr Xformer (ITC) Correction module, and therefore so are all other modules that use that Power Meter module's data.

See the ION Setup online help, available from www.schneider-electric.com, for instructions on how to configure PT/CT correction on your device.

See the ION Reference, available from www.schneider-electric.com, for detailed information about the Instr Xformer Correction (ITC) module and how it applies PT/CT correction to your device.

Transformer line loss compensation

Transformer Loss Compensation (TLC) is the method for compensating for the measurable losses that occur when there is a physical separation between the meter and the actual billing point.

Transformer Loss Compensation (TLC) is used when a meter's actual location is different from the electrical location where change of ownership occurs; for example, where meters are connected on the low-voltage side of power transformers when the ownership change occurs on the high-side of the transformer. Meters are usually installed on the low-voltage side of a transformer because it is more cost-effective. There are also cases where change of ownership can occur halfway along a transmission line where it is impractical to install a meter. In this case, power metering must again be compensated.

NOTE: Due to the variation in installations, advanced knowledge of power systems and connection methods is required before transformer loss compensation can be properly implemented. Data parameters should only be programmed by qualified personnel that have appropriate training and experience with Transformer Loss Compensation calculations.

See the *Transformer Line Loss Calculations* technical note available from www.schneider-electric.com.

Time of use

Time of use (TOU) is often used when a utility has set up schedules with different rates based on time of day, type of day and date when energy is consumed.

You can view the TOU active rates and seasons through your meter's display.

See the ION Setup online help, available from www.schneider-electric.com, for instructions on how to configure time of use on your meter.

See the ION Reference, available from www.schneider-electric.com, for a description of the Time of use module and its settings.

Related Topics

- Data viewing using your meter's display

Specifications

The specifications contained in this section are subject to change without notice. See your product's technical datasheet at www.schneider-electric.com for the most up-to-date and complete specifications.

See your device's installation sheet for information related to installation.

Mechanical characteristics

ION7400 panel mount meter with integrated display and PM89RD96 remote display

IP degree of protection	Display: IP54 Meter body: IP30 (except connectors)
Mounting position	Vertical
Display type	1/4 VGA color graphic TFT LCD, 320 x 240 resolution
Display backlight	White LED
Viewable area	70.6 x 52.9 mm (2.78 x 2.08 in)
Maximum number of option modules	4 (based on mechanical stress and required IP rating)

ION7403 DIN-mount meter

IP degree of protection	Meter body: IP30 (except connectors)
Mounting position	Horizontal TS35 DIN rail
Maximum number of option modules	4 (based on mechanical stress and required IP rating)

Electrical characteristics

NOTE: Reactive energy and demand values are based on the fundamental, and do not include higher harmonics. Other energy and demand values are measured using the entire signal including harmonics. Contact Technical Support for more information.

Measurement accuracy

IEC 62053-22 - active energy	Class 0.2S
IEC 62053-24 - reactive energy	Class 0.5S
IEC 61557-12	PMD/SD/K70/0.2 and PMD/SS/K70/0.2
Active power	± 0.2% IEC 61557-12 Class 0.2
Reactive power	± 1% IEC 61557-12 Class 1
Apparent power	± 0.5% IEC 61557-12 Class 0.5
Current (per phase)	± 0.2% IEC 61557-12 Class 0.2
Voltage (L-N)	± 0.2% IEC 61557-12 Class 0.2
Frequency	± 0.02% IEC 61557-12 Class 0.02

Power quality

IEC 61000-4-30 IEC 62586-1	Class S
Voltage unbalance	± 0.2% IEC 61557-12 Class 0.2
Voltage harmonics	± 1% IEC 61557-12 Class 1
Voltage THD	± 1% IEC 61557-12 Class 1
Current harmonics	± 1% IEC 61557-12 Class 1
Current THD	± 1% IEC 61557-12 Class 1
Flicker	IEC 61000-4-30 Class S

Voltage inputs

Maximum VT/PT primary	1.0 MV AC
Specified accuracy range	57 to 400 V L-N / 100 to 690 V L-L (Wye) or 100 to 600 V L-L (Delta) UL Listed up to 347 V L-N / 600 V L-L
Measurement category	CAT III
Overload	600 V L-N / 1035V L-L
Impedance	5 MΩ
Specified accuracy frequency	42 to 69 Hz (50/60 Hz nominal)

Current inputs

CT secondary	Nominal: 5 A (Class 0.2S) or 1 A (Class 0.5S)
Measured current	50 mA – 10 A
Starting current	5 mA
Withstand	20 A continuous 50 A at 10 sec/hr 500 A at 1 sec/hr
Impedance	< 0.3 mΩ
Frequency	42 to 69 Hz (50/60 Hz nominal)
Burden	< 0.024 VA at 10 A

AC control power

Operating range	50/60 Hz ± 10%: 90 to 415 V AC L-N ± 10%
Installation category	CAT III
Burden	7.2 W / 18.0 VA max at 415 V AC (meter only) 18 W / 36.0 VA max at 415 V AC (fully optioned meter)
Frequency	45 to 65 Hz
Ride-through time	100 ms (6 cycles at 60 Hz) min., any condition 200 ms (12 cycles at 60 Hz) typ., 120 V AC 500 ms (30 cycles at 60 Hz) typ., 415 V AC

DC control power

Operating range	120 to 300 V DC \pm 10%
Burden	6 W max at 300 V DC (meter only) 17 W max at 300 V DC (fully optioned meter)
Ride-through time	100 ms (6 cycles at 60 Hz) min., any condition

Digital outputs

Number	1
Type	Form A solid-state
Maximum load voltage	30 V AC / 60 V DC
Maximum load current	75mA
ON resistance	13 – 40 Ω at 25 °C (77 °F)
Signal type	Continuous or pulse
Pulse frequency	\leq 25 Hz

Digital inputs

Number	3
Type	Externally excited
Event timestamp accuracy	\pm 1 ms
Voltage OFF	0 - 1.7 V AC / 0 - 2.5 V DC
Voltage ON	4- 30 V AC / 4- 60 V DC
Frequency	\leq 25 Hz
IRIG-B	IRIG-B00x format (unmodulated IRIG-B time code) Coded expressions 0 to 7 are supported but the year data is not used.
Response time	20 ms
Pulse width	20 ms
Current draw	ON: \leq 2.5 mA at maximum voltage OFF: \leq 0.5 mA

Environmental characteristics

Operating temperature	-25 °C to Max temp (-13 °F to Max temp) Maximum operation temperature is based on the quantity and type of attached option modules. See <i>Maximum operating temperature</i> , page 166.
Storage temperature	-40 to 85 °C (-40 to 185 °F)
Humidity rating	5 – 95% RH non-condensing Maximum dewpoint: 37 °C (99 °F)
Pollution degree	2
Altitude	< 3000 m (9843 ft)
Location/mounting	Not suitable for wet locations For indoor use only Must be permanently connected and fixed

Maximum operating temperature

Max temp	PM89M2600 Digital (2 out, 6 in)	PM89M0024 Analog (2 out, 4 in)
70 °C (158 °F)	0 – 4	0,1
70 °C (158 °F)	0	2
60 °C (140 °F)	1, 2	2 – 4

LEDs**Energy pulsing LEDs (visible and infrared) located on top of meter**

Type	Visible orange, infrared
Wavelength	611 nm peak (orange) 940 nm (infrared)
Maximum pulse rate	42 – 69 Hz (based on line frequency)

WATT and VAR energy pulsing LEDs (visible and infrared) located on integrated display

Type	Visible orange, infrared
Wavelength	611 nm peak (orange) 940 nm (infrared)
Maximum pulse rate	42 – 69 Hz (based on line frequency)

EMC (electromagnetic compatibility)

Product standards	IEC 62052-11 IEC 61326-1
Immunity to electrostatic discharge	IEC 61000-4-2
Immunity to radiated fields	IEC 61000-4-3
Immunity to fast transients	IEC 61000-4-4
Immunity to surges	IEC 61000-4-5
Immunity to voltage dips and interruptions	IEC 61000-4-11
Immunity to magnetic fields	IEC 61000-4-8
Immunity to ring waves	IEC 61000-4-12
Immunity to conducted disturbances, 2 - 150 kHz	CLC/TR 50579
Radiated and conducted emissions	FCC part 15 Class B, EN55022 Class B, ICES-003 Class B, EN55011
Surge withstand capacity (SWC)	ANSI C37.90.1
Harmonic current emissions	IEC 61000-3-2
Flicker (voltage fluctuation) limits	IEC 61000-3-3

Mechanical compliance

Vibration	IEC 60068-2-6
Shock	IEC 60068-2-27

Safety

Safety construction	IEC/EN 61010-1 ed.3, CAT III, 400 VLN / 690 V LL UL 61010-1 ed.3 and CSA-C22.2 No. 61010-1 ed.3, CATIII, 347 V LN / 600 V LL IEC/EN 62052-11, Protective Class II
---------------------	---

Ethernet communications

Number of ports	2 (the second connector functions as an Ethernet switch for networking devices)
Maximum cable length	100 m (328 ft), per TIA/EIA 568-5-A
Cable type	CAT5/5e UTP (use unshielded connector only)
Mode	10Base-T, 100Base-TX, Auto-MDIX
Data rate	up to 100 Mbps

RS-485 communications

Number of ports	1
Maximum cable length	1200 m (4000 ft)
Maximum number of devices (unit loads)	Up to 32 devices on the same bus
Parity	None, even, odd
Baud rate	2400 – 115200, recommend 19200

Optical port communications

Number of ports	1
Type	ANSI C12.18
Parity	None, even, odd
Baud rate	2400, 4800, 9600, 19200 baud

USB communications

Number of ports	1 mini-B USB, 1 type A USB
-----------------	----------------------------

Real-time clock

Clock drift (time error)	20 ppm max at 25 °C (77 °F)
Battery backup time	Minimum 7 years under specified storage conditions

Remote display

IP degree of protection	Front: IP54 Rear: IP30
Cable	CAT5/5e UTP (use unshielded connector only)

Option modules

METSEPM89M0024 Analog (2 out, 4 in)

Maximum number of modules	4
Input resistance	< 300 Ω (current mode) > 500 kΩ (voltage mode)
Maximum input current	20 mA
Maximum input voltage	30 V DC
Maximum meter operating temperature	25 °C to Max temp (-13 °F to Max temp) Maximum operation temperature is based on the quantity and type of attached option modules. See <i>Maximum operating temperature, page 166</i> .

METSEPM89M2600 Digital (2 out, 4 in)

Maximum number of modules	4
Maximum input voltage	30 V AC / 60 V DC
Maximum output voltage	250 V AC / 30 V DC
Maximum output current	8 A @ 250 V AC or 5 A @ 24 V DC, 20k cycles (resistive)
Maximum meter operating temperature	-25 °C to Max temp (-13 °F to Max temp) Maximum operation temperature is based on the quantity and type of attached option modules. See <i>Maximum operating temperature, page 166</i> .

Other

Meter start time	Typical: 18 seconds (power up to measurement)
Meter memory	512 MB
Data update rate	Regular data: 1 second High-speed: 50 – 60 Hz half-cycle

Related Topics

- Analog input applications
- Analog output applications

Schneider Electric
35 rue Joseph Monier
92500 Rueil Malmaison
France

+ 33 (0) 1 41 29 70 00

www.schneider-electric.com

As standards, specifications, and design change from time to time,
please ask for confirmation of the information given in this publication.

© 2015 – Schneider Electric. All rights reserved.

7EN02-0374-00